MEMORANDUM OF COMMON PROVISIONS

Approved Form MCP

Section 91A Transfer of Land Act 1958 *Victorian Land Titles Office*

Lodged by:
Name: HWL EBSWORTH LAWYERS
Customer Code: 0985X

Pr	
Th	
un	07/05/2013
pu	\$55.10
reg	MCP
Re	

AA2192



This memorandum (containing 13 page(s)) contains provisions which are intended for inclusion in instruments to be subsequently lodged for registration.

ALL THOSE PROVISIONS IN THE ATTACHED PAGES NUMBERED 2-13

Approval No. 325955A

MCP

113378961/v1

1. The provisions are to be numbered consecutively from number 1.
2. The back of this form is not to be used.
3. Further pages may be added but each page should be consecutively numbered.
4. To be used for the inclusion of covenants and easements in mortgages, transfers and leases

AA2192

07/05/2013

\$55.10

MCP



PROVISIONS

PRELIMINARY

- A. This MCP has been prepared by or on behalf of Peet Craigieburn Pty Ltd in order to regulate the siting, form and design of residential development in accordance with the PEET Victoria Design Guidelines, so as to create a high level of amenity for owners and residents of allotments within the plan of subdivision.
- B. The provisions of this MCP are incorporated into the restrictions created by the plan of subdivision.
- C. The plan of subdivision and this MCP restrict certain lot owners from developing a lot other than in accordance with the building envelope plans.
- D. The building envelope plans provide details of approved building envelopes.
- E. This MCP, in conjunction with the plan of subdivision, provides the information necessary to interpret the approved building envelopes.
- F. Some of the matters addressed in this MCP are not covered by or are amendments to the Regulations and Scheme.
- G. This MCP is retained by the Registrar of Titles pursuant to section 91(A) of the Transfer of Land Act.

PROVISIONS

Any building to be constructed on lots to which this MCP and the plan of subdivision apply and for which the construction would require a building permit must be sited within the approved building envelope subject to any specific encroachments allowed outside the approved building envelope pursuant to this MCP and the plan of subdivision.

Approval No. 325955A

MCP

- 1. The provisions are to be numbered consecutively from number 1.
- 2. **The back of this form is not to be used.**
- 3. Further pages may be added but each page should be consecutively numbered.
- 4. To be used for the inclusion of covenants and easements in mortgages, transfers and leases

AA2192

07/05/2013 \$55.10 MCP



1 Text of restrictions

The siting of a building within the approved building envelope is subject to the restrictions imposed by this MCP, the plan of subdivision and any other applicable control.

1.1 Minimum street setbacks (regulation 409 and clause 54.03-1)

A building must be set back from a street alignment in accordance with regulation 409 (Minimum street setbacks) in Part 4 of the Regulations and clause 54.03-1 in the Scheme, except as specified below.

A building on a lot must be set back from a street boundary not less than the distance specified in respect of that boundary on the building envelope plans.

Balconies, façade treatments, verandahs, open porches, covered walkways, pergolas and porticos that are less than 9.0 metres high and decks, sunblinds, shade sails, eaves, screens as per regulation 419(5)(d) or 419(6) of the Regulations, steps, landings, flues, pipes, fuel tanks, water tanks, heating and cooling equipment, fascias and gutters, may encroach not more than 2.4 metres into the minimum front setback and 1.5 metres into the setback on a side street or laneway for a dwelling, garage or carport. A covered balcony or verandah on the second storey of a building that is less than 9.0 metres may encroach not more than 1.5 metres into the minimum front setback.

A garage and / or carport on a lot more than 300 square metres must be set back at least 5 metres from the front boundary of the lot and be a minimum of 840 millimetres behind the front building line.

A garage and / or carport on a lot less than 300 square metres must either be set back less than 3.9 metres or more than 5.0 metres from the front boundary and be a minimum of 350 millimetres behind the front building line.

1.2 Building height (regulation 410 and clause 54.03-2)

The height of a building on a lot must be in accordance with Regulation 410 (Building height) in Part 4 of the Regulations and clause 54.03-2 in the Scheme, except as specified below.

The height of a building on a lot must not exceed 10.0 metres unless the slope of the natural ground level at any cross section wider than 8 metres of the site of the building is 7.5 degrees or more, in which case the maximum building height should not exceed 12.0 metres.

(C0270174-1)

Approval No. 325955A

MCP

1. The provisions are to be numbered consecutively from number 1.
2. **The back of this form is not to be used.**
3. Further pages may be added but each page should be consecutively numbered.
4. To be used for the inclusion of covenants and easements in mortgages, transfers and leases

AA2192

07/05/2013 \$55.10 MCP



1.3 Site coverage (regulation 411 and clause 54.03-3)

The site area covered by buildings on a lot should be in accordance with regulation 411 (Site coverage) in Part 4 of the Regulations and clause 54.03-3 in the scheme, except as specified below.

Buildings must not occupy more than 75 per cent of the lot.

1.4 Side and rear setbacks (regulation 414 and clause 54.04-1)

Side and rear setbacks on a lot must be in accordance with regulation 414 (Side and rear setbacks) in Part 4 of the Regulations and clause 54.04-1 in the Scheme, except as specified below.

A building on a lot must be set back from a side or rear boundary not less than the distance specified in respect of that boundary on the building envelope plans.

Balconies, façade treatments, verandahs, open porches, covered walkways, pergolas and porticos that are less than 9.0 metres high and decks, sunblinds, shade sails, eaves, screens as per regulation 419(5)(d) or 419(6) of the Regulations, steps, landings, flues, pipes, fuel tanks, water tanks, heating and cooling equipment, fascias and gutters, may encroach not more than 600 millimetres into the setback zone.

1.5 Walls on boundaries (regulation 415 and clause 54.04-2)

Walls constructed on a boundary must be in accordance with regulation 415 (Walls on boundaries) in Part 4 of the Regulations and clause 54.05-2 in the Scheme, except as specified below.

A dwelling wall built on the boundary must not exceed a total height of 4.5 metres. A dwelling wall built on the boundary must not exceed a total length of 20 metres or the length of any existing abutting wall, whichever is the greater.

A dwelling on a lot that is less than 300 square metres is permitted to be sited as indicated by the side boundary profiles and building envelope plans provided for the lot.

1.6 Private Open Space (regulation 421 and clause 54.05-2)

For a dwelling on lots less than 300 square metres, the only minimum private open space required is 25.00 square metres with each dimension (length and width) being a minimum of 3.0 metres.

Approval No. 325955A

MCP

1. The provisions are to be numbered consecutively from number 1.
2. The back of this form is not to be used.
3. Further pages may be added but each page should be consecutively numbered.
4. To be used for the inclusion of covenants and easements in mortgages, transfers and leases

AA2192

07/05/2013

\$55.10

MCP



2 Notes on this MCP

- 2.1 Ground level after engineering works associated with subdivision is to be regarded as natural ground level.
- 2.2 Buildings must not cover registered easements unless approved by the relevant authority.
- 2.3 Edge lots are those lots that are part of the same certified plan of subdivision but share one or more common boundaries with or otherwise adjoin a lot that is not part of the same certified plan of subdivision. Regulation 406 in Part 4 of the Regulations and clause 56.04-2 in the Scheme, apply to each edge lot irrespective of Section 1 of this MCP.

3 General definitions

In this MCP:

- (1) **approved building envelope** means the building envelope shown for a particular lot in the building envelope plans and has the same meaning as in regulation 406 of the Regulations;
- (2) **building** has the same meaning as in the Building Act;
- (3) **Building Act** means the act of the Victorian Parliament known as the *Building Act* 1993 and any re-enactment or replacement of that act;
- (4) **building envelope** means an area within each lot (defined by the particular lot setbacks) where development of a dwelling, shed, garage and / or carport is allowed subject to the particular provisions of this MCP, the plan of subdivision and the Scheme;
- (5) **building envelope plans** means the plans which are attached to this MCP and to the plan of subdivision which show the approved building envelopes, certain setbacks and other related matters for the lots within the plan of subdivision;
- (6) **building permit** means a building permit in terms of the Building Act;
- (7) **control** includes a restriction in terms of the *Subdivision Act* 1988, an agreement under section 173 of the *Planning and Environment Act* 1987 (PE Act), a provision of an Act (other than the Building Act), a regulation (other than the Building Regulations), a requirement of a referral authority (in terms of section 55 of the PE Act) or an order of a Court or tribunal, which relates to the siting of a Building;

Approval No. 325955A

MCP

1. The provisions are to be numbered consecutively from number 1.
2. The back of this form is not to be used.
3. Further pages may be added but each page should be consecutively numbered.
4. To be used for the inclusion of covenants and easements in mortgages, transfers and leases

AA2192

07/05/2013 \$55.10 MCP



-
- (8) **dwelling** has the same meaning as in the Scheme;
 - (9) **frontage** has the same meaning as in the Scheme;
 - (10) **front building line** is defined as the front wall of the dwelling, which does not include bay windows, porches, porticos and verandahs or any other permitted encroachments.
 - (11) **height** has the same meaning as in the Regulations;
 - (12) **lot** has the same meaning as in the Building Act;
 - (13) **MCP** means this memorandum of common provisions;
 - (14) **on the boundary** means a setback of up to 150 millimetres from the lot / property boundary is deemed to be on the boundary;
 - (15) **plan of subdivision** means the plan of subdivision to which this MCP is incorporated by way of a restrictions on that plan of subdivision;
 - (16) **private open space** has the same meaning as in the Regulations;
 - (17) **recreational private open space** has the same meaning as in the Regulations;
 - (18) **Regulations** means the *Building Regulations 2006* or any subsequent regulations made pursuant to the Building Act which relate the siting of a Building;
 - (19) **Scheme** means the planning scheme of the local authority responsible for the land contained within the plan of subdivision;
 - (20) **secluded private open space** has the same meaning as in the Regulations;
 - (21) **setback** has the same meaning as in the Regulations;
 - (22) **side boundary** means a boundary of a lot that runs between and connects the street frontage of the lot to the rear boundary of the lot;
 - (23) **site coverage** has the same meaning as in the Regulations;
 - (24) **storey** has the same meaning as in the Scheme;

Approval No. 325955A

MCP

- 1. The provisions are to be numbered consecutively from number 1.
- 2. **The back of this form is not to be used.**
- 3. Further pages may be added but each page should be consecutively numbered.
- 4. To be used for the inclusion of covenants and easements in mortgages, transfers and leases

AA2192

07/05/2013

\$55.10

MCP



-
- (25) **PEET Craigieburn Pty Ltd** means Peet Craigieburn Pty Ltd ACN 100 290 640 or any associated entity or related body corporate of Peet Craigieburn Pty Ltd, including but not limited to Peet Ltd ACN 008 665 834;
 - (26) **street**, for the purposes of determining street setbacks, means any road other than a footway or carriageway easement; and
 - (27) **window** has the same meaning as in the Regulations.

Approval No. 325955A

MCP

- 1. The provisions are to be numbered consecutively from number 1.
- 2. The back of this form is not to be used.
- 3. Further pages may be added but each page should be consecutively numbered.
- 4. To be used for the inclusion of covenants and easements in mortgages, transfers and leases

AA2192

07/05/2013

\$55.10

MCP



BOUNDARY PROFILES

Boundary Profile Allocation Diagram

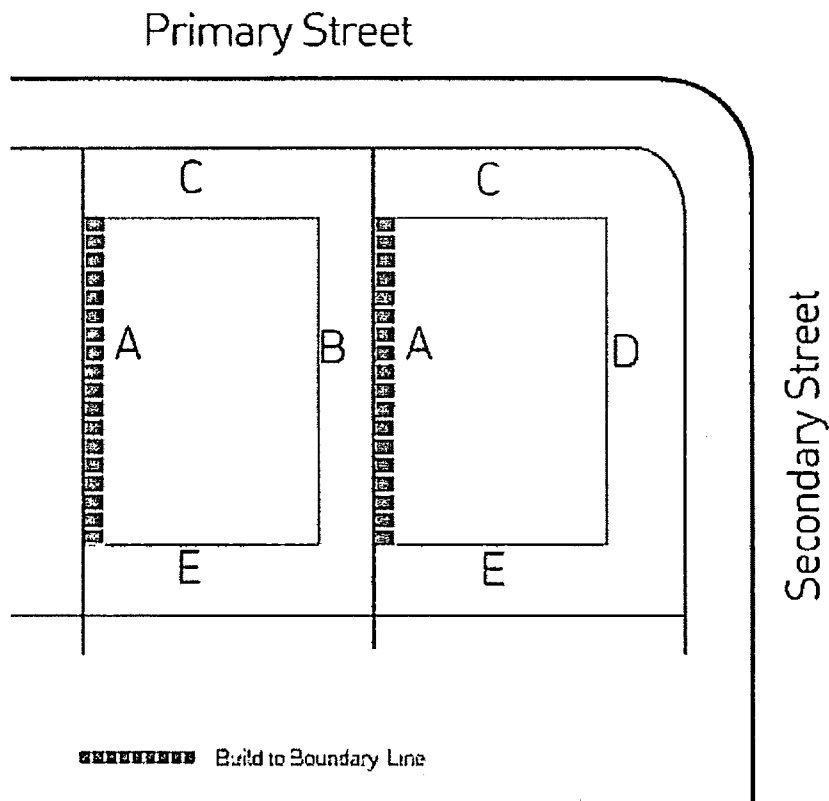

Approval No. 325955A

MCP

1. The provisions are to be numbered consecutively from number 1.
2. The back of this form is not to be used.
3. Further pages may be added but each page should be consecutively numbered.
4. To be used for the inclusion of covenants and easements in mortgages, transfers and leases

AA2192

07/05/2013 \$55.10 MCP



BOUNDARY PROFILES

A- Side Boundary Profile: Zero Lot Line

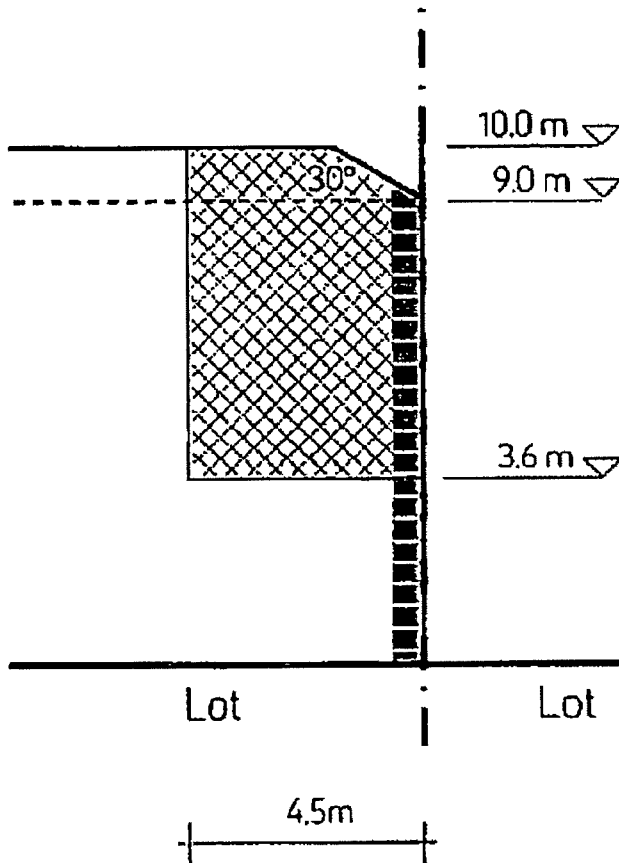

EASEMENT REQUIREMENT

Where a profile when applied covers an easement, the portion of the profile above the easement cannot be considered for approval/built upon. This may vary only in the circumstances where building on the easement receives prior written consent of the relevant authority.

- Lot Boundary
- Build to Boundary Line
- Overlooking Control Area (Habitable Room Windows, Balconies, Terraces)

Approval No. 325955A

MCP

1. The provisions are to be numbered consecutively from number 1.
2. The back of this form is not to be used.
3. Further pages may be added but each page should be consecutively numbered.
4. To be used for the inclusion of covenants and easements in mortgages, transfers and leases

AA2192

07/05/2013 \$55.10 MCP

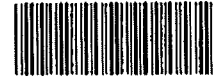

BOUNDARY PROFILES

B- Side Boundary Profile: Setback From Boundary

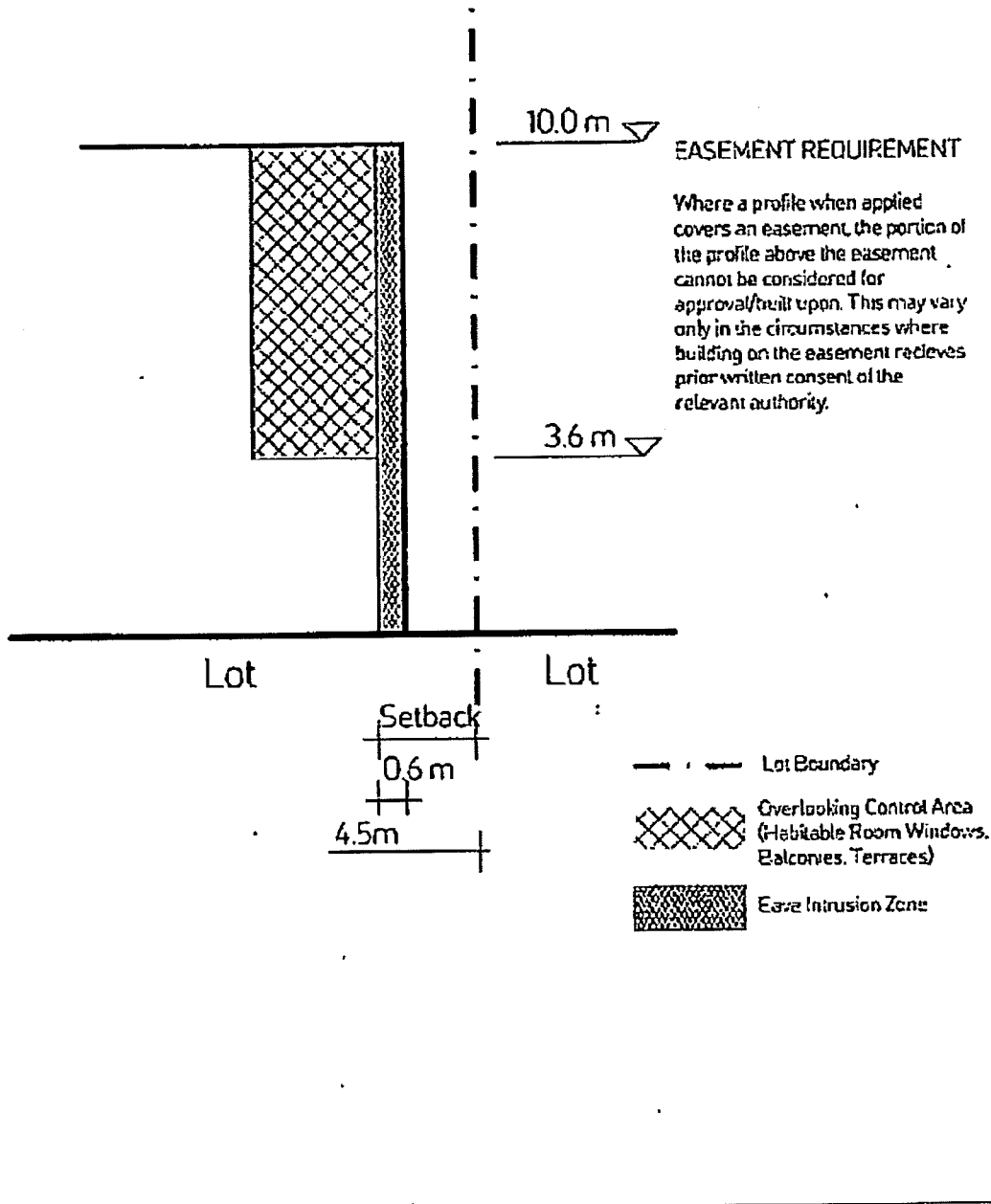

Approval No. 325955A

MCP

1. The provisions are to be numbered consecutively from number 1.
2. The back of this form is not to be used.
3. Further pages may be added but each page should be consecutively numbered.
4. To be used for the inclusion of covenants and easements in mortgages, transfers and leases

AA2192

07/05/2013 \$55.10 MCP



BOUNDARY PROFILES

C- Front Boundary Profile: Setback From Boundary

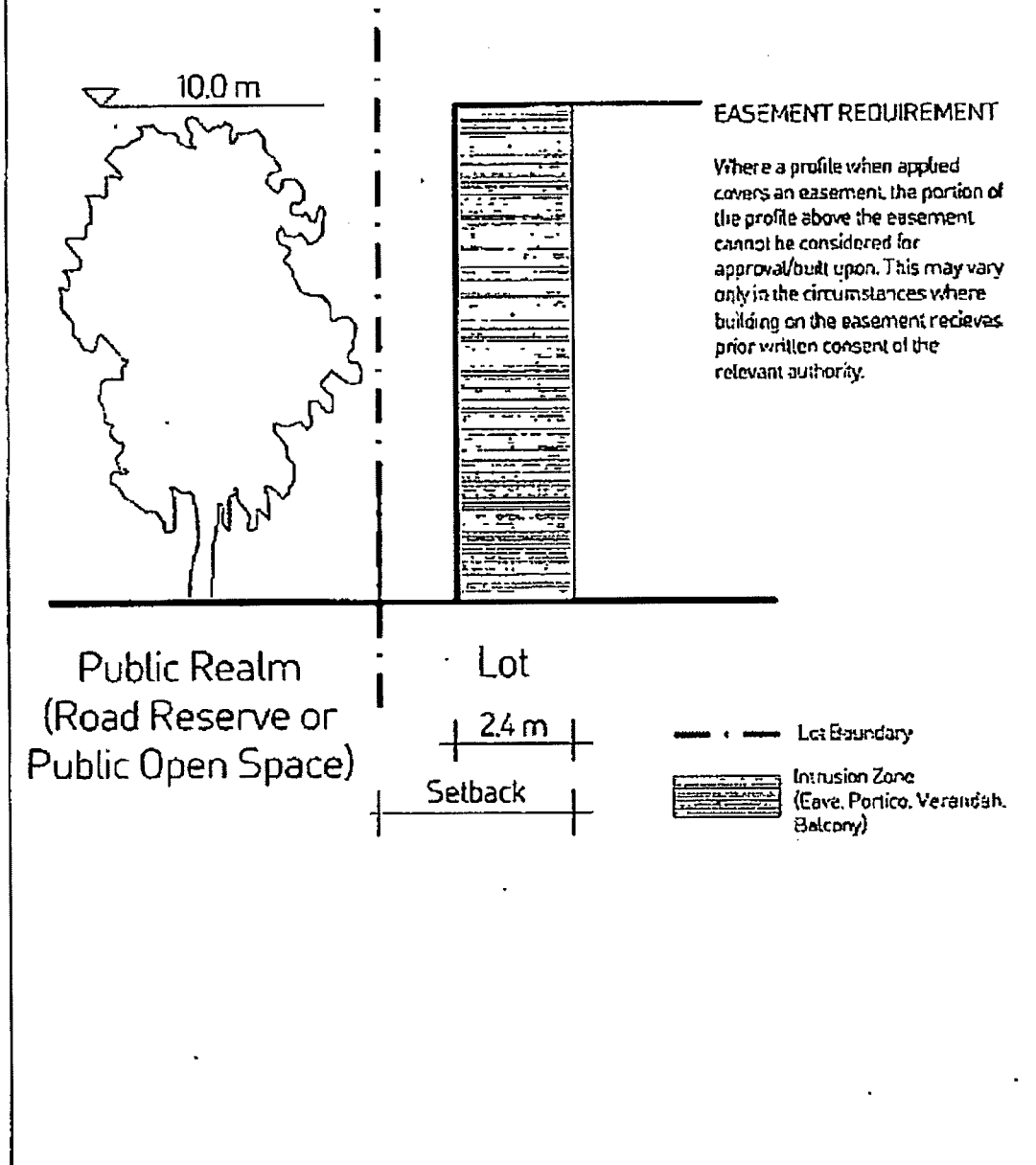

Approval No. 325955A

MCP

1. The provisions are to be numbered consecutively from number 1.
2. The back of this form is not to be used.
3. Further pages may be added but each page should be consecutively numbered.
4. To be used for the inclusion of covenants and easements in mortgages, transfers and leases

AA2192

07/05/2013

\$55.10

MCP



BOUNDARY PROFILES

D- Front Boundary Profile: Setback From Boundary

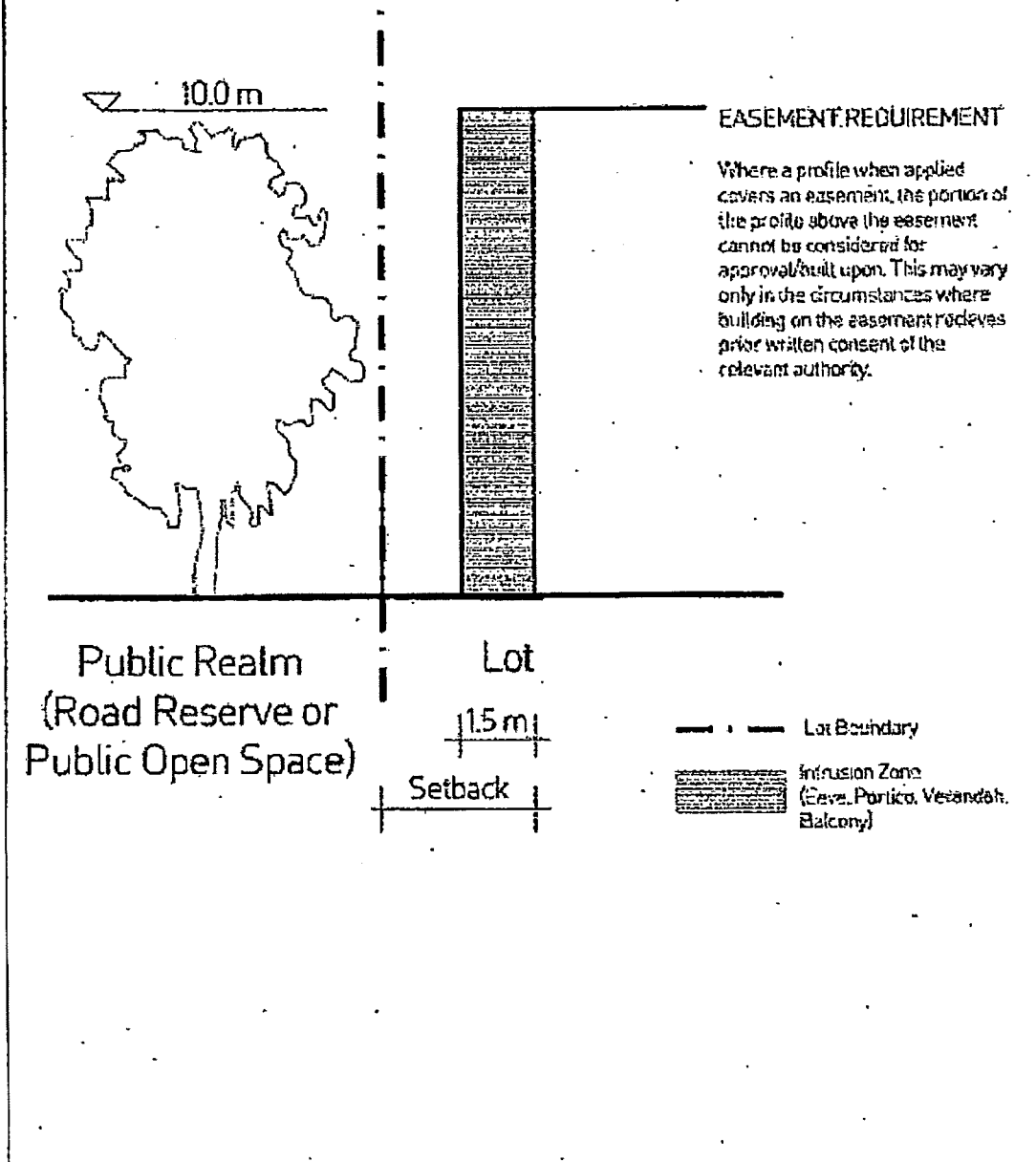

Approval No. 325955A

MCP

1. The provisions are to be numbered consecutively from number 1.
2. The back of this form is not to be used.
3. Further pages may be added but each page should be consecutively numbered.
4. To be used for the inclusion of covenants and easements in mortgages, transfers and leases

AA2192

07/05/2013 \$55.10 MCP



BOUNDARY PROFILES

E- Back Boundary Profile: Setback From Boundary

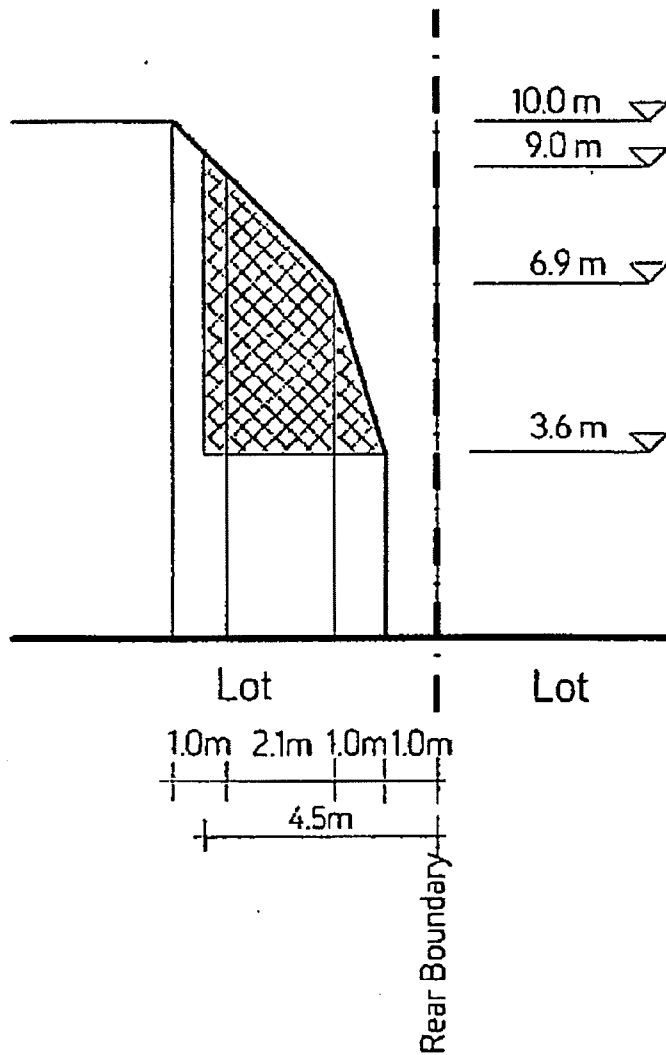

EASEMENT REQUIREMENT

Where a profile when applied covers an easement, the portion of the profile above the easement cannot be considered for approval/built upon. This may vary only in the circumstances where building on the easement receives prior written consent of the relevant authority.

--- · --- Lot Boundary

Overlooking Control Area (Habitable Room Windows, Balconies, Terraces)

Approval No. 325955A

MCP

1. The provisions are to be numbered consecutively from number 1.
2. **The back of this form is not to be used.**
3. Further pages may be added but each page should be consecutively numbered.
4. To be used for the inclusion of covenants and easements in mortgages, transfers and leases