

LEGEND

- Rock Retaining Wall shown as:-
- Sleeper Retaining Wall shown as:-
- Landscape Retaining Wall shown as:-
- Sewer line
- Sewer Manhole
- Roofwater Drainage line and Catch Pit
- Stormwater Drainage Line
- Stormwater Manhole
- Stormwater Pit
- Water Main
- Water Conduit
- Water Service Point of Entry
- Underground Electricity, Street Light, Electricity Pillar & NBN
- Developer Fencing
- Concrete Pathway
- Landscape Street Tree
- Zero Setback Building Line
- Indicative Building Envelope
- Proposed Services Easement
- Indicative Parking Access Location
- Bin Pads

ADDITIONAL NOTES:

Allotments used as Multiple Residential Allotments in accordance with the approved Plan of Development may have a reduced primary road setback to 3.0metres as noted on the Plan of Development Table.

Compaction of any fill material placed on this site shall be completed to level one inspection and testing services in accordance with AS3798-2007.

Location of sewer, roofwater, stormwater, water reticulation and electricity lines, manholes and pits are those shown on engineering design drawings, supplied by Peak Urban and may differ from the as-constructed location.

Plan of Development information Supplied by RPS Group PLC.

Copyright © Veris Australia Pty Ltd
04 April 2022.

Plot Date: 06 Apr, 2022
 Computer File Ref: 30109-St5J-SP-(A).dwg

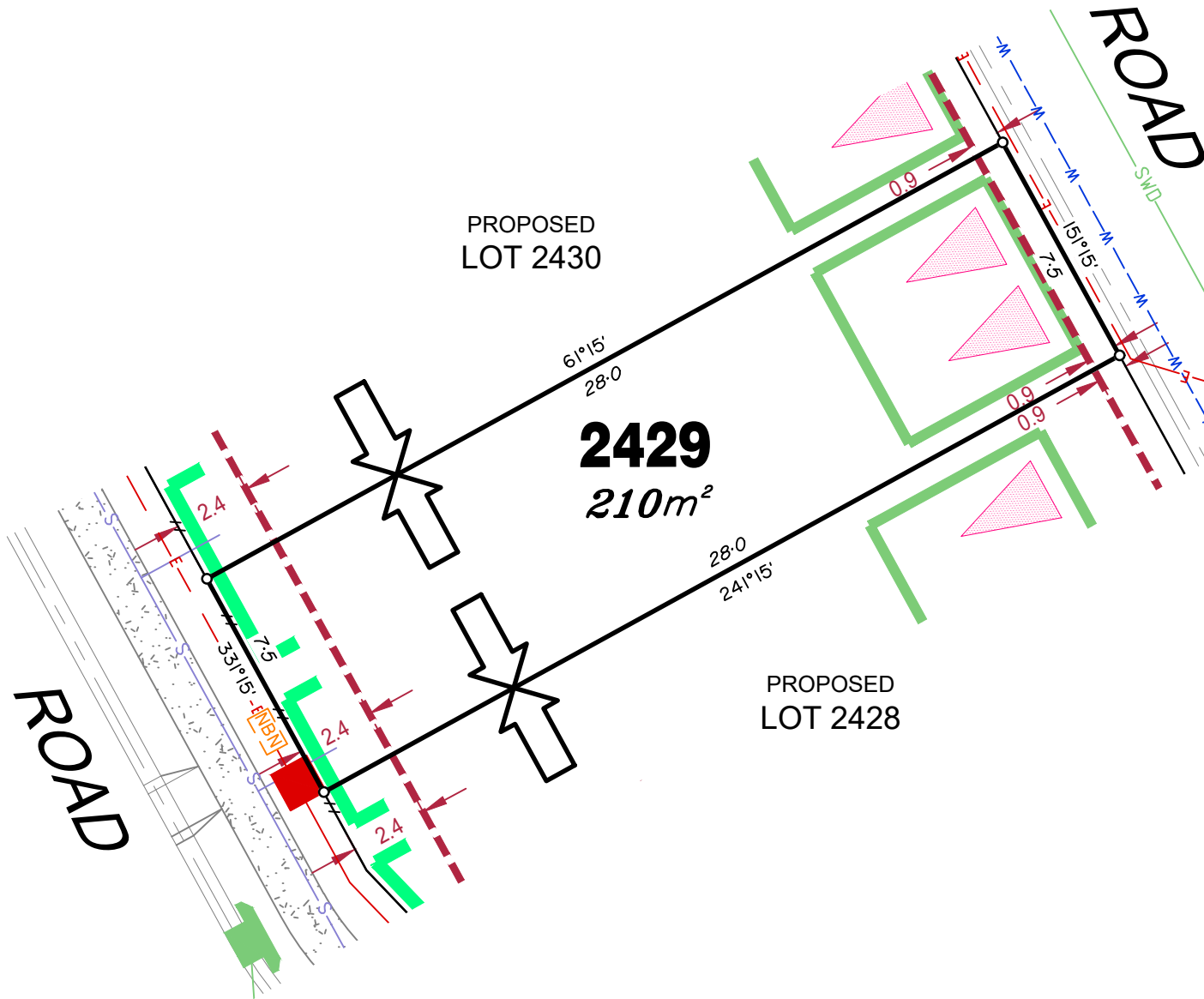

LEGEND

Rock Retaining Wall shown as:-	
Sleeper Retaining Wall shown as:-	
Landscape Retaining Wall shown as:-	
Sewer line	
Sewer Manhole	
Roofwater Drainage line and Catch Pit	
Stormwater Drainage Line	
Stormwater Manhole	
Stormwater Pit	
Water Main	
Water Conduit	
Water Service Point of Entry	
Underground Electricity, Street Light, Electricity Pillar & NBN	
Developer Fencing	
Concrete Pathway	
Landscape Street Tree	
Zero Setback Building Line	
Indicative Building Envelope	
Proposed Services Easement	
Indicative Parking Access Location	
Bin Pads	

ADDITIONAL NOTES:

Allotments used as Multiple Residential Allotments in accordance with the approved Plan of Development may have a reduced primary road setback to 3.0metres as noted on the Plan of Development Table.

Compaction of any fill material placed on this site shall be completed to level one inspection and testing services in accordance with AS3798-2007.



















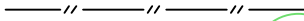

Location of sewer, roofwater, stormwater, water reticulation and electricity lines, manholes and pits are those shown on engineering design drawings, supplied by Peak Urban and may differ from the as-constructed location.

Plan of Development information Supplied by RPS Group PLC.

Copyright © Veris Australia Pty Ltd
04 April 2022.

Plot Date: 06 Apr, 2022
Computer File Ref: 30109-St5J-SP-(A).dwg

LEGEND

Rock Retaining Wall shown as:-	
Sleeper Retaining Wall shown as:-	
Landscape Retaining Wall shown as:-	
Sewer line	
Sewer Manhole	
Roofwater Drainage line and Catch Pit	
Stormwater Drainage Line	
Stormwater Manhole	
Stormwater Pit	
Water Main	
Water Conduit	
Water Service Point of Entry	
Underground Electricity, Street Light, Electricity Pillar & NBN	
Developer Fencing	
Concrete Pathway	
Landscape Street Tree	
Zero Setback Building Line	
Indicative Building Envelope	
Proposed Services Easement	
Indicative Parking Access Location	
Bin Pads	

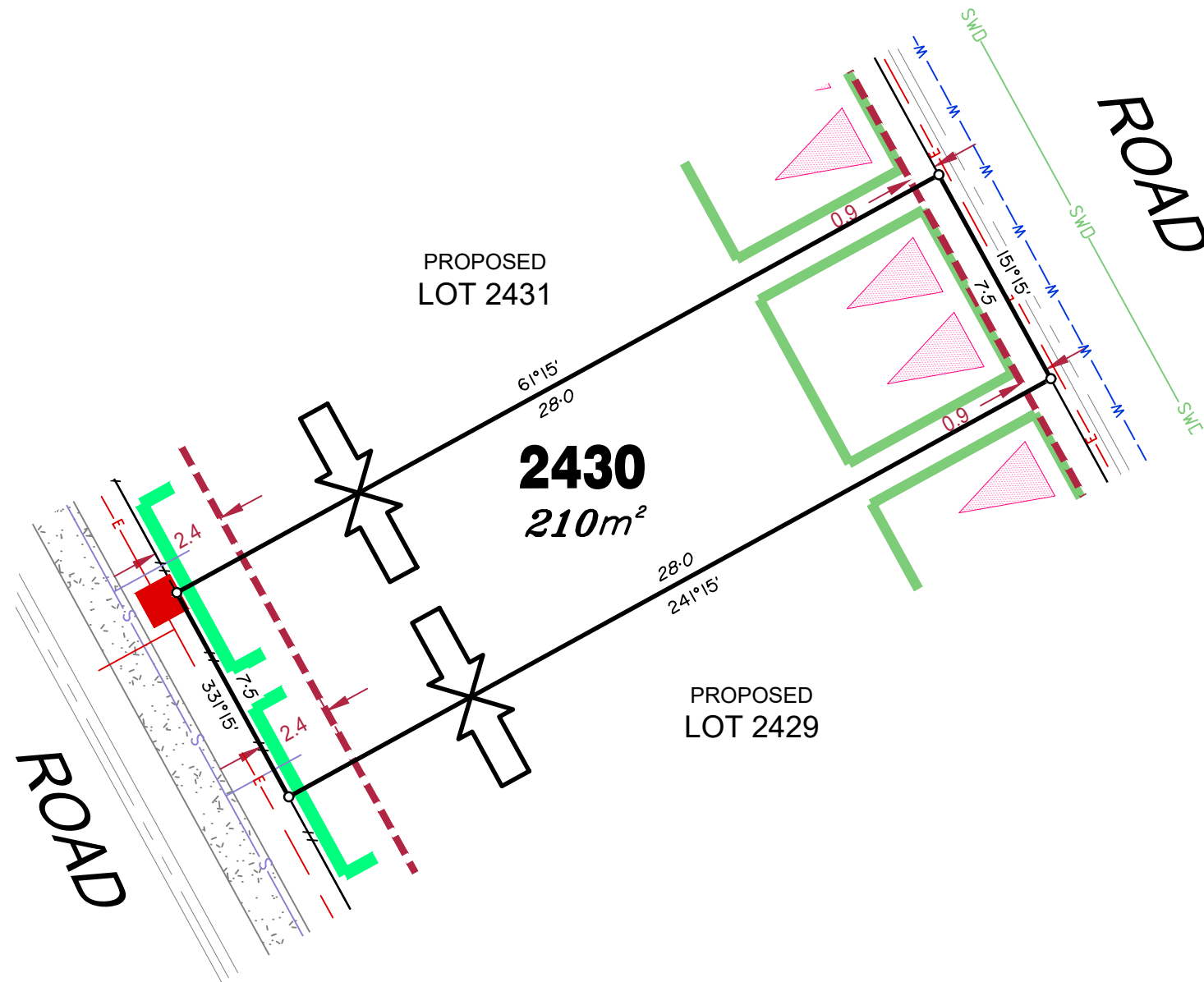

ADDITIONAL NOTES:

Allotments used as Multiple Residential Allotments in accordance with the approved Plan of Development may have a reduced primary road setback to 3.0metres as noted on the Plan of Development Table.

Compaction of any fill material placed on this site shall be completed to level one inspection and testing services in accordance with AS3798-2007.

Location of sewer, roofwater, stormwater, water reticulation and electricity lines, manholes and pits are those shown on engineering design drawings, supplied by Peak Urban and may differ from the as-constructed location.

Plan of Development information Supplied by RPS Group PLC.

Copyright © Veris Australia Pty Ltd
04 April 2022.

Plot Date: 06 Apr, 2022
Computer File Ref: 30109-St5J-SP-(A).dwg

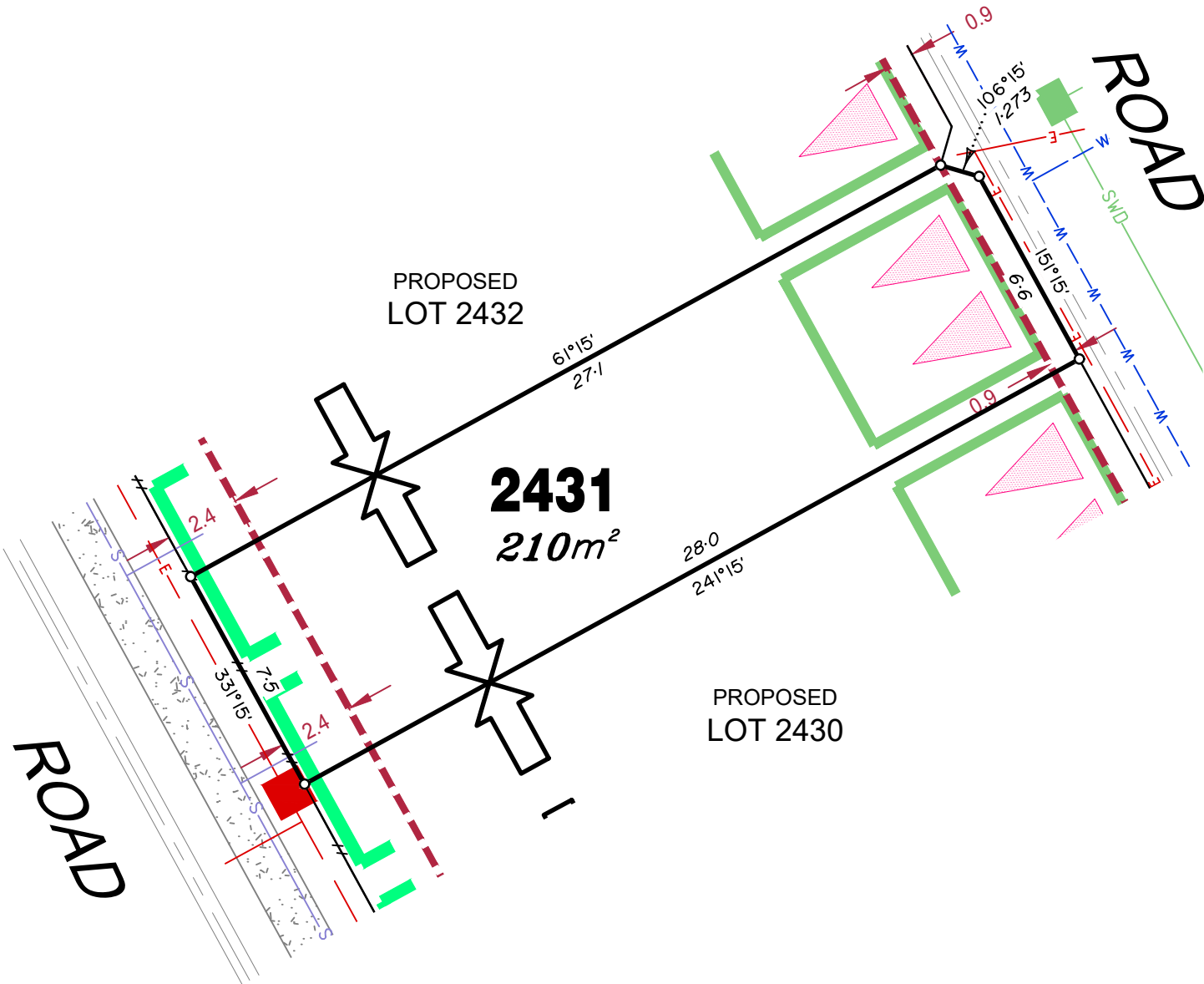

LEGEND

Rock Retaining Wall shown as:-	
Sleeper Retaining Wall shown as:-	
Landscape Retaining Wall shown as:-	
Sewer line	
Sewer Manhole	
Roofwater Drainage line and Catch Pit	
Stormwater Drainage Line	
Stormwater Manhole	
Stormwater Pit	
Water Main	
Water Conduit	
Water Service Point of Entry	
Underground Electricity, Street Light, Electricity Pillar & NBN	
Developer Fencing	
Concrete Pathway	
Landscape Street Tree	
Zero Setback Building Line	
Indicative Building Envelope	
Proposed Services Easement	
Indicative Parking Access Location	
Bin Pads	

ADDITIONAL NOTES:

Allotments used as Multiple Residential Allotments in accordance with the approved Plan of Development may have a reduced primary road setback to 3.0metres as noted on the Plan of Development Table.

Compaction of any fill material placed on this site shall be completed to level one inspection and testing services in accordance with AS3798-2007.

Location of sewer, roofwater, stormwater, water reticulation and electricity lines, manholes and pits are those shown on engineering design drawings, supplied by Peak Urban and may differ from the as-constructed location.

Plan of Development information Supplied by RPS Group PLC.

Copyright © Veris Australia Pty Ltd
04 April 2022.

Plot Date: 06 Apr, 2022
Computer File Ref: 30109-St5J-SP-(A).dwg

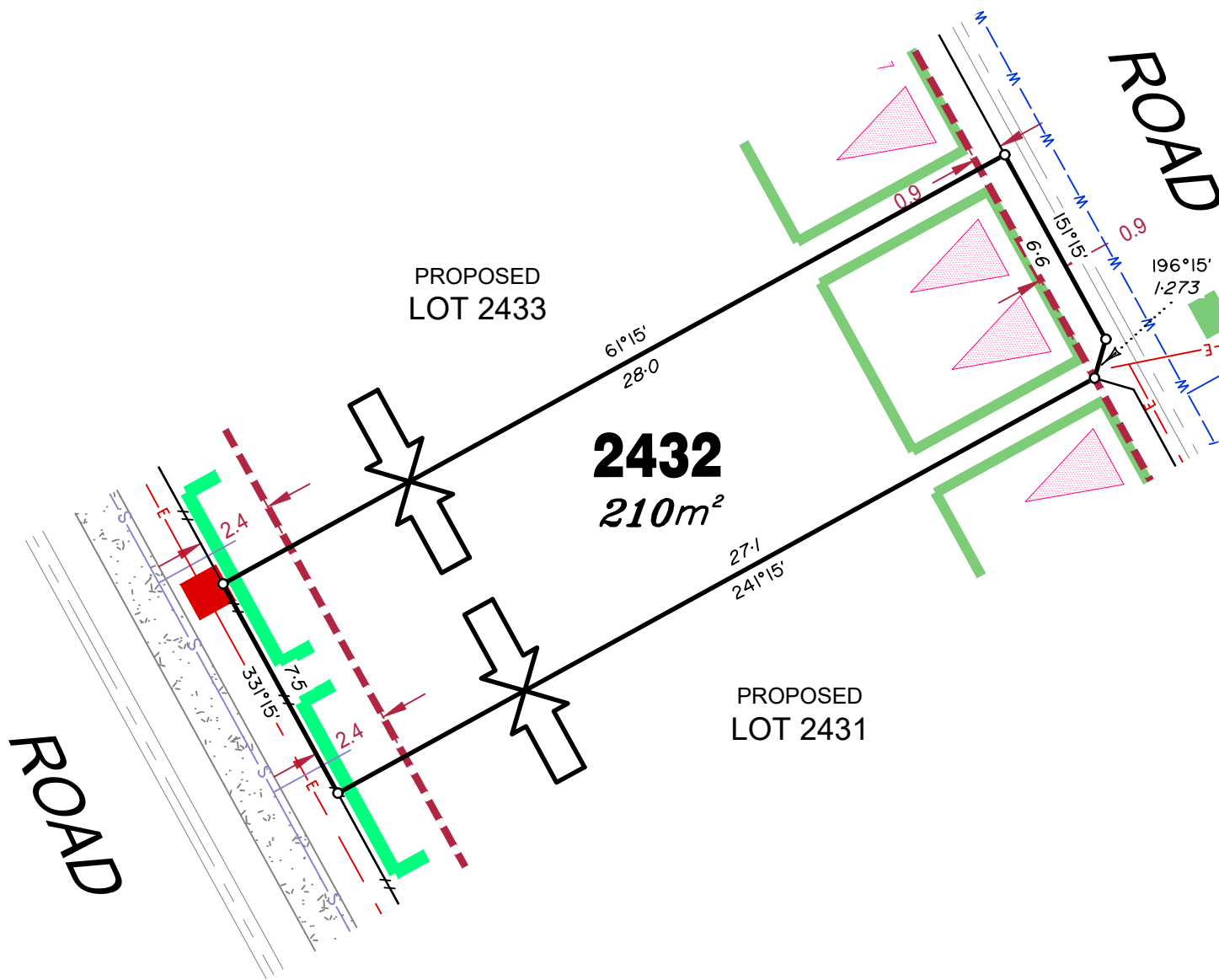

LEGEND

Rock Retaining Wall shown as:-	
Sleeper Retaining Wall shown as:-	
Landscape Retaining Wall shown as:-	
Sewer line	
Sewer Manhole	
Roofwater Drainage line and Catch Pit	
Stormwater Drainage Line	
Stormwater Manhole	
Stormwater Pit	
Water Main	
Water Conduit	
Water Service Point of Entry	
Underground Electricity, Street Light, Electricity Pillar & NBN	
Developer Fencing	
Concrete Pathway	
Zero Setback Building Line	
Proposed Services Easement	
Indicative Parking Access Location	
Bin Pads	
Landscape Street Tree	
Indicative Building Envelope	

ADDITIONAL NOTES:

Allotments used as Multiple Residential Allotments in accordance with the approved Plan of Development may have a reduced primary road setback to 3.0metres as noted on the Plan of Development Table.

Compaction of any fill material placed on this site shall be completed to level one inspection and testing services in accordance with AS3798-2007.

Location of sewer, roofwater, stormwater, water reticulation and electricity lines, manholes and pits are those shown on engineering design drawings, supplied by Peak Urban and may differ from the as-constructed location.

Plan of Development information Supplied by RPS Group PLC.

Copyright © Veris Australia Pty Ltd
04 April 2022.

Plot Date: 06 Apr, 2022
Computer File Ref: 30109-St5J-SP-(A).dwg

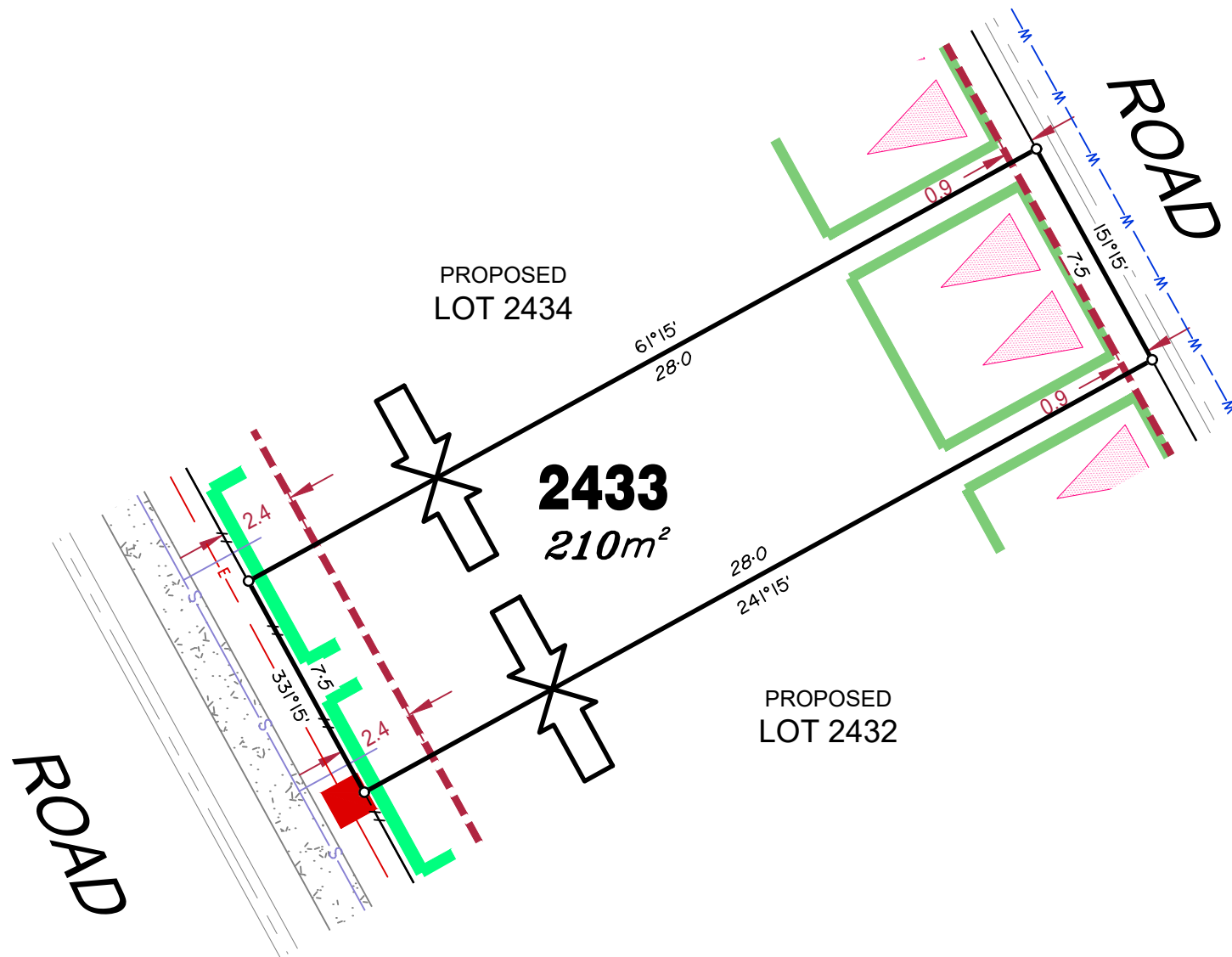

LEGEND

Rock Retaining Wall shown as:-	
Sleeper Retaining Wall shown as:-	
Landscape Retaining Wall shown as:-	
Sewer line	
Sewer Manhole	
Roofwater Drainage line and Catch Pit	
Stormwater Drainage Line	
Stormwater Manhole	
Stormwater Pit	
Water Main	
Water Conduit	
Water Service Point of Entry	
Underground Electricity, Street Light, Electricity Pillar & NBN	
Developer Fencing	
Concrete Pathway	
Landscape Street Tree	
Zero Setback Building Line	
Indicative Building Envelope	
Proposed Services Easement	
Indicative Parking Access Location	
Bin Pads	

ADDITIONAL NOTES:

Allotments used as Multiple Residential Allotments in accordance with the approved Plan of Development may have a reduced primary road setback to 3.0metres as noted on the Plan of Development Table.

Compaction of any fill material placed on this site shall be completed to level one inspection and testing services in accordance with AS3798-2007.























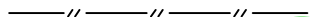

Location of sewer, roofwater, stormwater, water reticulation and electricity lines, manholes and pits are those shown on engineering design drawings, supplied by Peak Urban and may differ from the as-constructed location.

Plan of Development information Supplied by RPS Group PLC.

Copyright © Veris Australia Pty Ltd
04 April 2022.

Plot Date: 06 Apr, 2022
 Computer File Ref: 30109-St5J-SP-(A).dwg

LEGEND

Rock Retaining Wall shown as:-		
Sleeper Retaining Wall shown as:-		
Landscape Retaining Wall shown as:-		
Sewer line		
Sewer Manhole		
Roofwater Drainage line and Catch Pit		
Stormwater Drainage Line		
Stormwater Manhole		
Stormwater Pit		
Water Main		
Water Conduit		
Water Service Point of Entry		
Underground Electricity, Street Light, Electricity Pillar & NBN		
Developer Fencing		
Concrete Pathway		Landscape Street Tree 
Zero Setback Building Line		Indicative Building Envelope 
Proposed Services Easement		
Indicative Parking Access Location		
Bin Pads		

ADDITIONAL NOTES:

Allotments used as Multiple Residential Allotments in accordance with the approved Plan of Development may have a reduced primary road setback to 3.0metres as noted on the Plan of Development Table.

Compaction of any fill material placed on this site shall be completed to level one inspection and testing services in accordance with AS3798-2007.

Location of sewer, roofwater, stormwater, water reticulation and electricity lines, manholes and pits are those shown on engineering design drawings, supplied by Peak Urban and may differ from the as-constructed location.

Plan of Development information Supplied by RPS Group PLC.

Copyright © Veris Australia Pty Ltd
04 April 2022.

Plot Date: 06 Apr, 2022
Computer File Ref: 30109-St5J-SP-(A).dwg

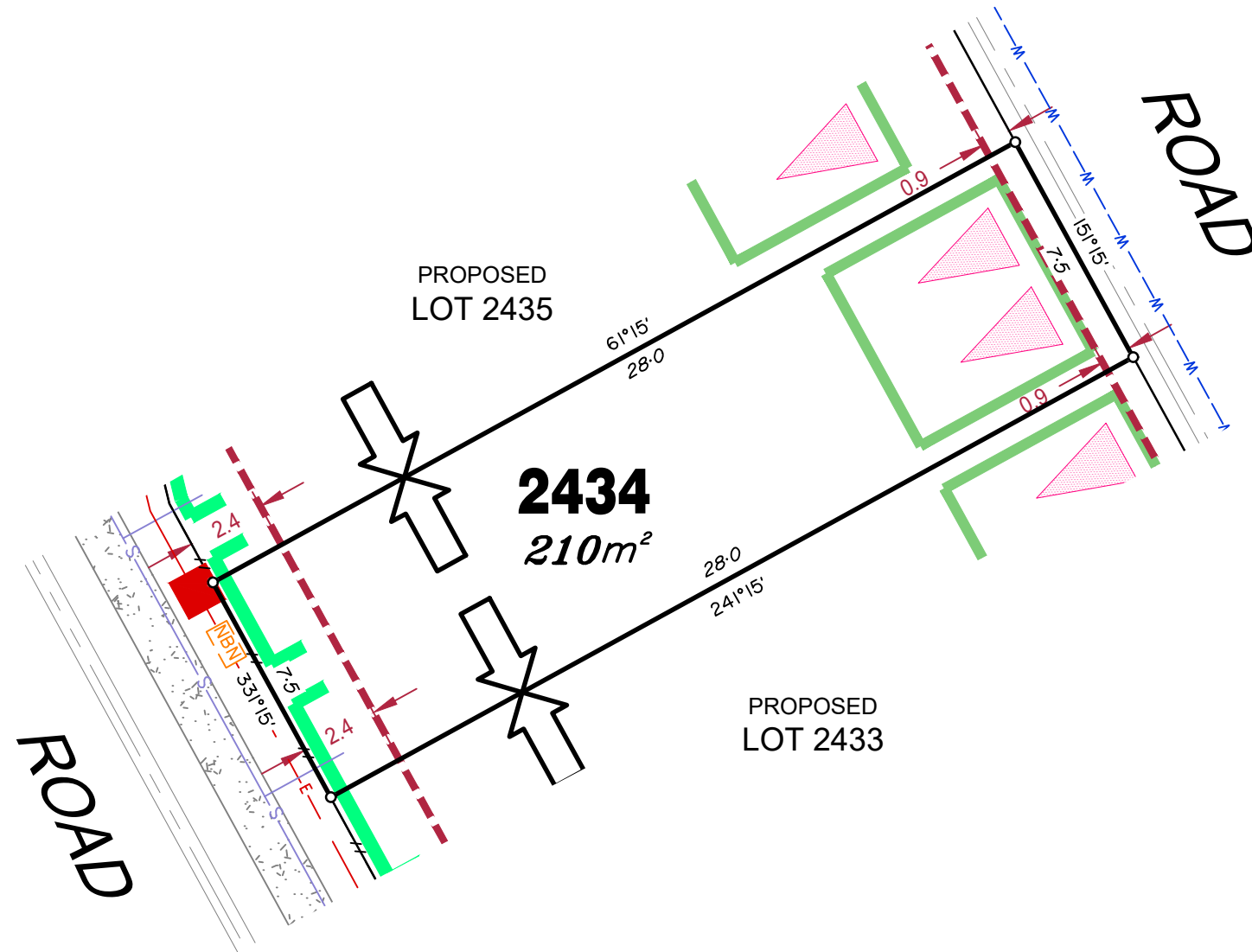

SANDY CREEK ROAD



















ROAD

ROAD

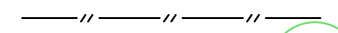
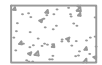
PROPOSED LOT 2437

2436
307m²

LEGEND

- Rock Retaining Wall shown as:- 
- Sleeper Retaining Wall shown as:- 
- Landscape Retaining Wall shown as:- 
- Sewer line 
- Sewer Manhole 
- Roofwater Drainage line and Catch Pit 
- Stormwater Drainage Line 
- Stormwater Manhole 
- Stormwater Pit 
- Water Main 
- Water Conduit 
- Water Service Point of Entry 
- Underground Electricity, Street Light, Electricity Pillar & NBN 
- Developer Fencing 
- Concrete Pathway 
- Landscape Street Tree 
- Zero Setback Building Line 
- Indicative Building Envelope 
- Proposed Services Easement 
- Indicative Parking Access Location 
- Bin Pads 

ADDITIONAL NOTES:

Allotments used as Multiple Residential Allotments in accordance with the approved Plan of Development may have a reduced primary road setback to 3.0metres as noted on the Plan of Development Table.

Compaction of any fill material placed on this site shall be completed to level one inspection and testing services in accordance with AS3798-2007.

Location of sewer, roofwater, stormwater, water reticulation and electricity lines, manholes and pits are those shown on engineering design drawings, supplied by Peak Urban and may differ from the as-constructed location.

Plan of Development information Supplied by RPS Group PLC.

Copyright © Veris Australia Pty Ltd
04 April 2022.

Plot Date: 06 Apr, 2022
Computer File Ref: 30109-St5J-SP-(A).dwg

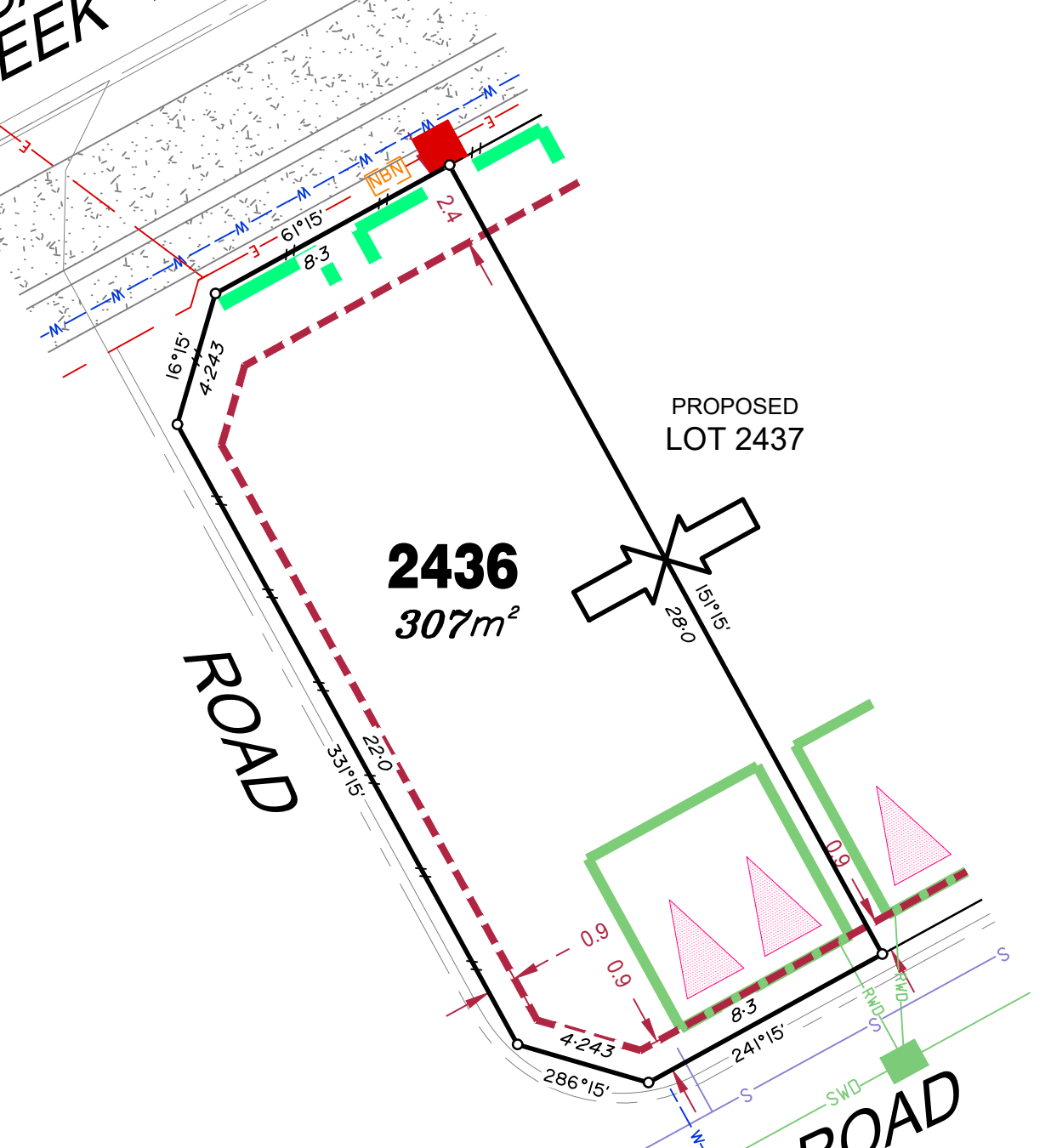

SANDY CREEK ROAD

PROPOSED LOT 2438

2437
210m²

PROPOSED LOT 2436

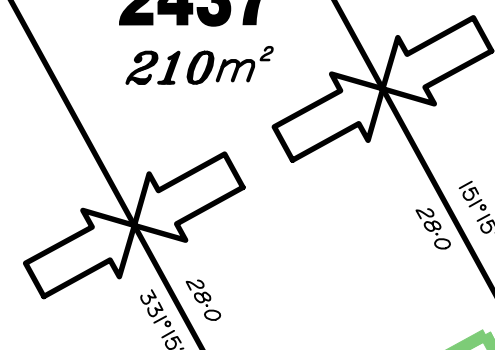

ROAD

LEGEND

- Rock Retaining Wall shown as:-
- Sleeper Retaining Wall shown as:-
- Landscape Retaining Wall shown as:-
- Sewer line
- Sewer Manhole
- Roofwater Drainage line and Catch Pit
- Stormwater Drainage Line
- Stormwater Manhole
- Stormwater Pit
- Water Main
- Water Conduit
- Water Service Point of Entry
- Underground Electricity, Street Light, Electricity Pillar & NBN
- Developer Fencing
- Concrete Pathway
- Landscape Street Tree
- Zero Setback Building Line
- Indicative Building Envelope
- Proposed Services Easement
- Indicative Parking Access Location
- Bin Pads

ADDITIONAL NOTES:

Allotments used as Multiple Residential Allotments in accordance with the approved Plan of Development may have a reduced primary road setback to 3.0metres as noted on the Plan of Development Table.

Compaction of any fill material placed on this site shall be completed to level one inspection and testing services in accordance with AS3798-2007.

Location of sewer, roofwater, stormwater, water reticulation and electricity lines, manholes and pits are those shown on engineering design drawings, supplied by Peak Urban and may differ from the as-constructed location.

Plan of Development information Supplied by RPS Group PLC.

Copyright © Veris Australia Pty Ltd
04 April 2022.

Plot Date: 06 Apr, 2022
Computer File Ref: 30109-St5J-SP-(A).dwg

SANDY CREEK ROAD

PROPOSED LOT 2438

2439
210m²

PROPOSED LOT 2440

ROAD

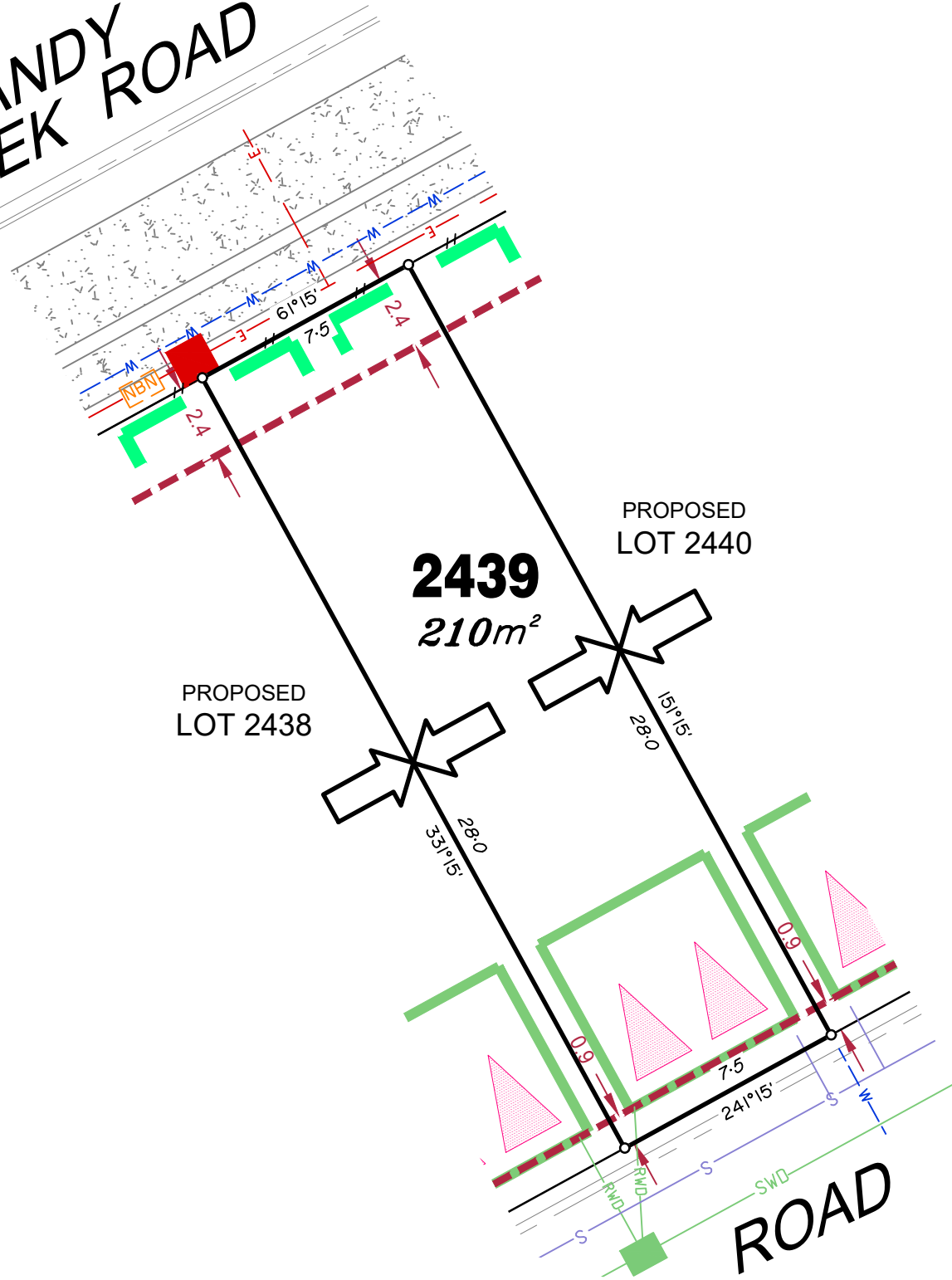

LEGEND

- Rock Retaining Wall shown as:-
- Sleeper Retaining Wall shown as:-
- Landscape Retaining Wall shown as:-
- Sewer line
- Sewer Manhole
- Roofwater Drainage line and Catch Pit
- Stormwater Drainage Line
- Stormwater Manhole
- Stormwater Pit
- Water Main
- Water Conduit
- Water Service Point of Entry
- Underground Electricity, Street Light, Electricity Pillar & NBN
- Developer Fencing
- Concrete Pathway
- Landscape Street Tree
- Zero Setback Building Line
- Indicative Building Envelope
- Proposed Services Easement
- Indicative Parking Access Location
- Bin Pads

ADDITIONAL NOTES:

Allotments used as Multiple Residential Allotments in accordance with the approved Plan of Development may have a reduced primary road setback to 3.0metres as noted on the Plan of Development Table.

Compaction of any fill material placed on this site shall be completed to level one inspection and testing services in accordance with AS3798-2007.

Location of sewer, roofwater, stormwater, water reticulation and electricity lines, manholes and pits are those shown on engineering design drawings, supplied by Peak Urban and may differ from the as-constructed location.

Plan of Development information Supplied by RPS Group PLC.

Copyright © Veris Australia Pty Ltd
04 April 2022.

Plot Date: 06 Apr, 2022
Computer File Ref: 30109-St5J-SP-(A).dwg

SANDY CREEK ROAD

PROPOSED LOT 2439







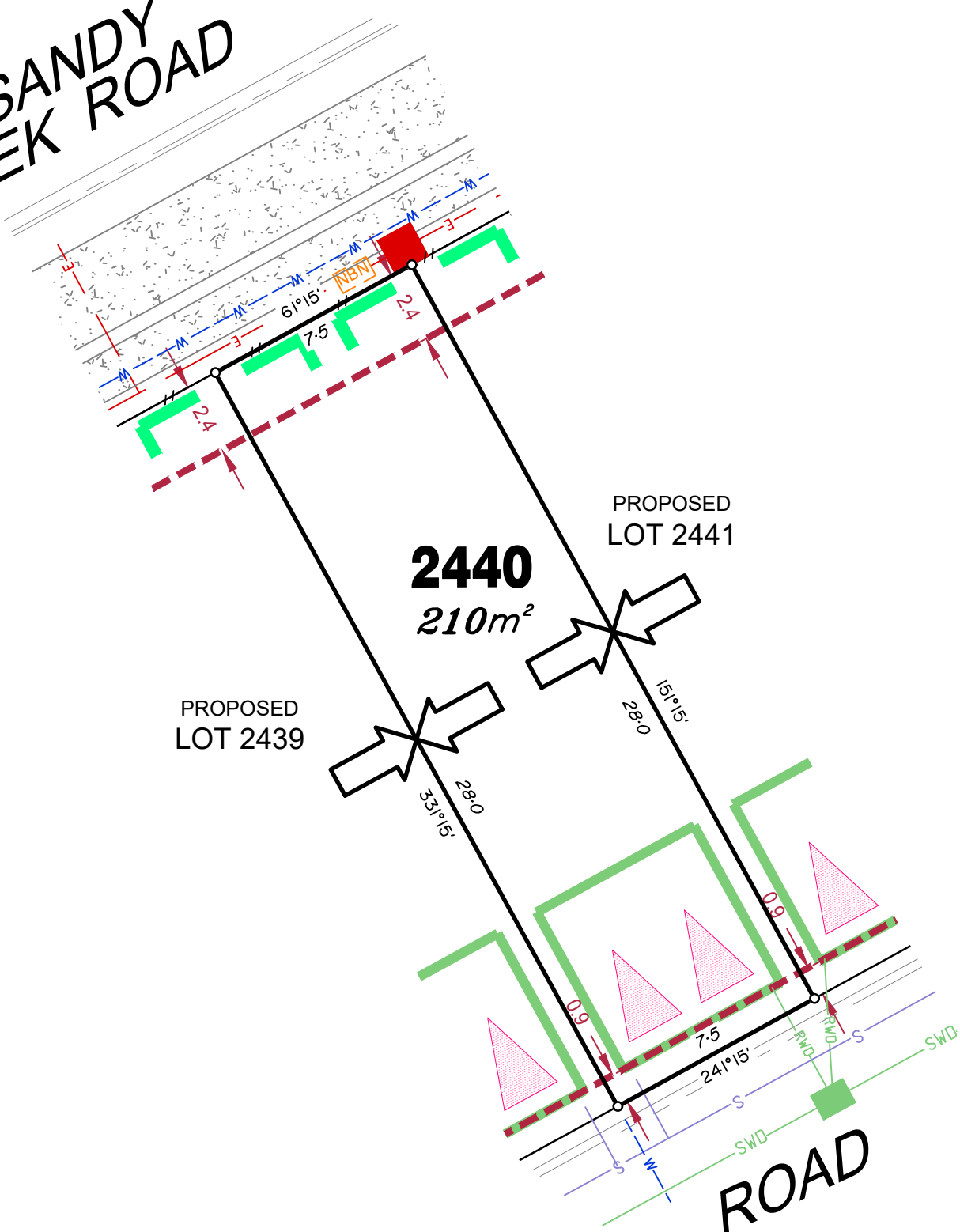













2440
210m²

PROPOSED LOT 2441

ROAD



LEGEND

- Rock Retaining Wall shown as:- 
- Sleeper Retaining Wall shown as:- 
- Landscape Retaining Wall shown as:- 
- Sewer line 
- Sewer Manhole 
- Roofwater Drainage line and Catch Pit 
- Stormwater Drainage Line 
- Stormwater Manhole 
- Water Main 
- Water Conduit 
- Water Service Point of Entry 
- Underground Electricity, Street Light, Electricity Pillar & NBN 
- Developer Fencing 
- Concrete Pathway 
- Landscape Street Tree 
- Zero Setback Building Line 
- Indicative Building Envelope 
- Proposed Services Easement 
- Indicative Parking Access Location 
- Bin Pads 

ADDITIONAL NOTES:

Allotments used as Multiple Residential Allotments in accordance with the approved Plan of Development may have a reduced primary road setback to 3.0metres as noted on the Plan of Development Table.

Compaction of any fill material placed on this site shall be completed to level one inspection and testing services in accordance with AS3798-2007.

Location of sewer, roofwater, stormwater, water reticulation and electricity lines, manholes and pits are those shown on engineering design drawings, supplied by Peak Urban and may differ from the as-constructed location.

Plan of Development information Supplied by RPS Group PLC.

Copyright © Veris Australia Pty Ltd
04 April 2022.

Plot Date: 06 Apr, 2022
Computer File Ref: 30109-St5J-SP-(A).dwg

SANDY CREEK ROAD

PROPOSED LOT 2442

2441
210m²

PROPOSED LOT 2440

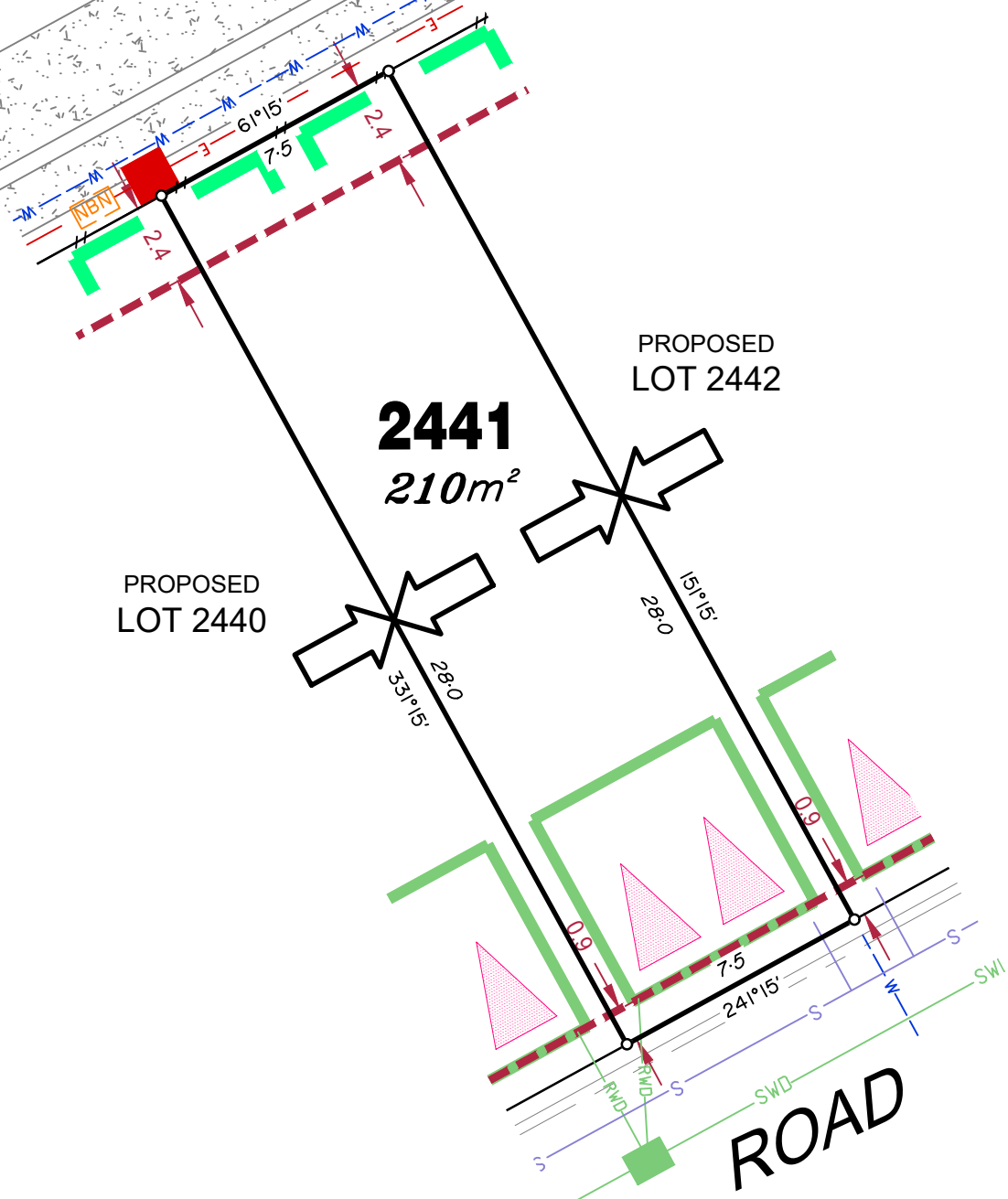

LEGEND

- Rock Retaining Wall shown as:-
- Sleeper Retaining Wall shown as:-
- Landscape Retaining Wall shown as:-
- Sewer line
- Sewer Manhole
- Roofwater Drainage line and Catch Pit
- Stormwater Drainage Line
- Stormwater Manhole
- Stormwater Pit
- Water Main
- Water Conduit
- Water Service Point of Entry
- Underground Electricity, Street Light, Electricity Pillar & NBN
- Developer Fencing
- Concrete Pathway
- Landscape Street Tree
- Zero Setback Building Line
- Indicative Building Envelope
- Proposed Services Easement
- Indicative Parking Access Location
- Bin Pads

ADDITIONAL NOTES:

Allotments used as Multiple Residential Allotments in accordance with the approved Plan of Development may have a reduced primary road setback to 3.0metres as noted on the Plan of Development Table.

Compaction of any fill material placed on this site shall be completed to level one inspection and testing services in accordance with AS3798-2007.

Location of sewer, roofwater, stormwater, water reticulation and electricity lines, manholes and pits are those shown on engineering design drawings, supplied by Peak Urban and may differ from the as-constructed location.

Plan of Development information Supplied by RPS Group PLC.

Copyright © Veris Australia Pty Ltd
04 April 2022.

Plot Date: 06 Apr, 2022
Computer File Ref: 30109-St5J-SP-(A).dwg

SANDY CREEK ROAD







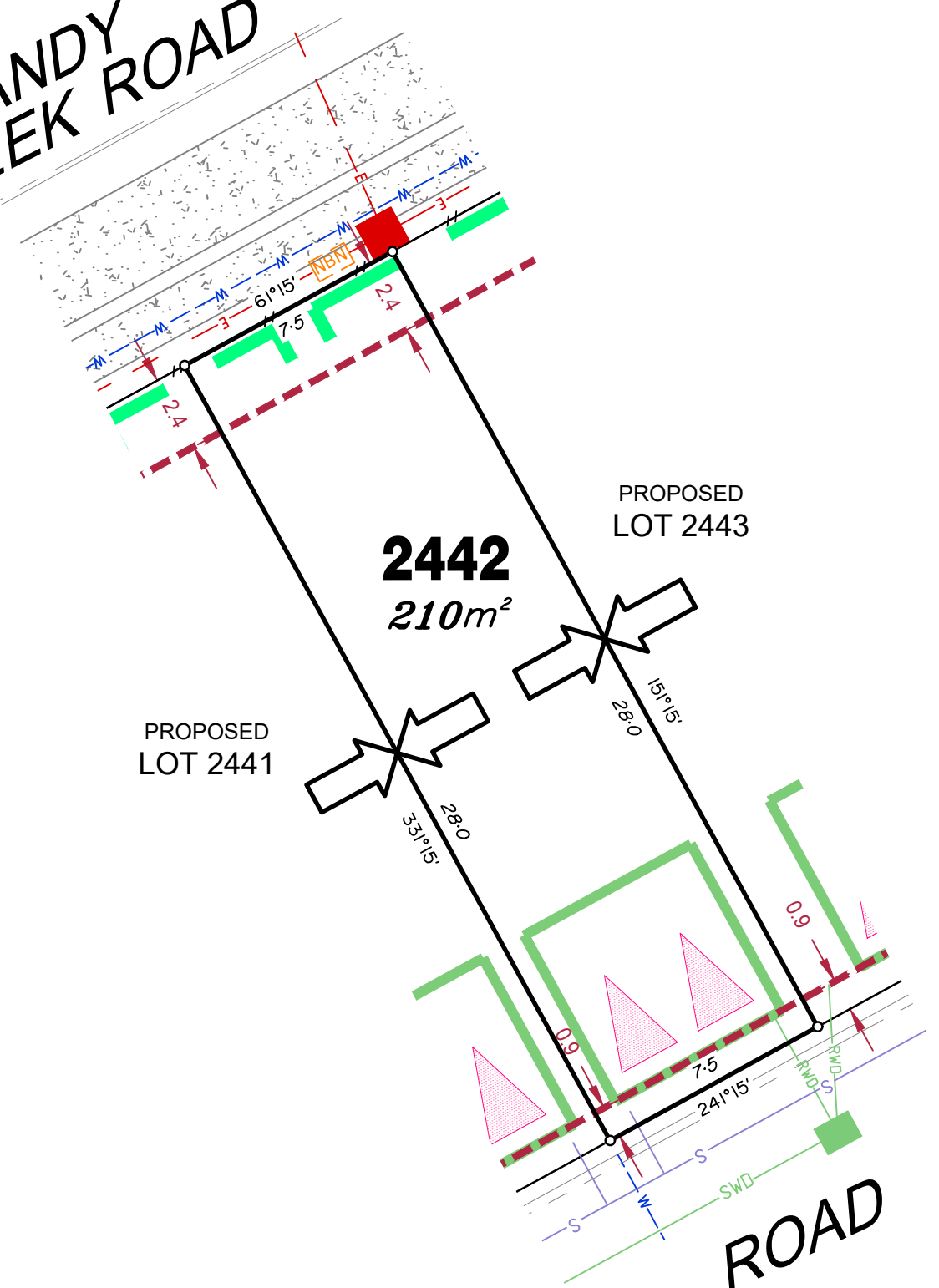











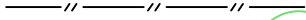

PROPOSED LOT 2443

2442
210m²

PROPOSED LOT 2441



LEGEND

- Rock Retaining Wall shown as:- 
- Sleeper Retaining Wall shown as:- 
- Landscape Retaining Wall shown as:- 
- Sewer line 
- Sewer Manhole 
- Roofwater Drainage line and Catch Pit 
- Stormwater Drainage Line 
- Stormwater Manhole 
- Water Main 
- Water Conduit 
- Water Service Point of Entry 
- Underground Electricity, Street Light, Electricity Pillar & NBN 
- Developer Fencing 
- Concrete Pathway 
- Landscape Street Tree 
- Zero Setback Building Line 
- Indicative Building Envelope 
- Proposed Services Easement 
- Indicative Parking Access Location 
- Bin Pads 

ADDITIONAL NOTES:

Allotments used as Multiple Residential Allotments in accordance with the approved Plan of Development may have a reduced primary road setback to 3.0metres as noted on the Plan of Development Table.

Compaction of any fill material placed on this site shall be completed to level one inspection and testing services in accordance with AS3798-2007.

Location of sewer, roofwater, stormwater, water reticulation and electricity lines, manholes and pits are those shown on engineering design drawings, supplied by Peak Urban and may differ from the as-constructed location.

Plan of Development information Supplied by RPS Group PLC.

Copyright © Veris Australia Pty Ltd
04 April 2022.

Plot Date: 06 Apr, 2022
Computer File Ref: 30109-St5J-SP-(A).dwg

ROAD

SANDY CREEK ROAD

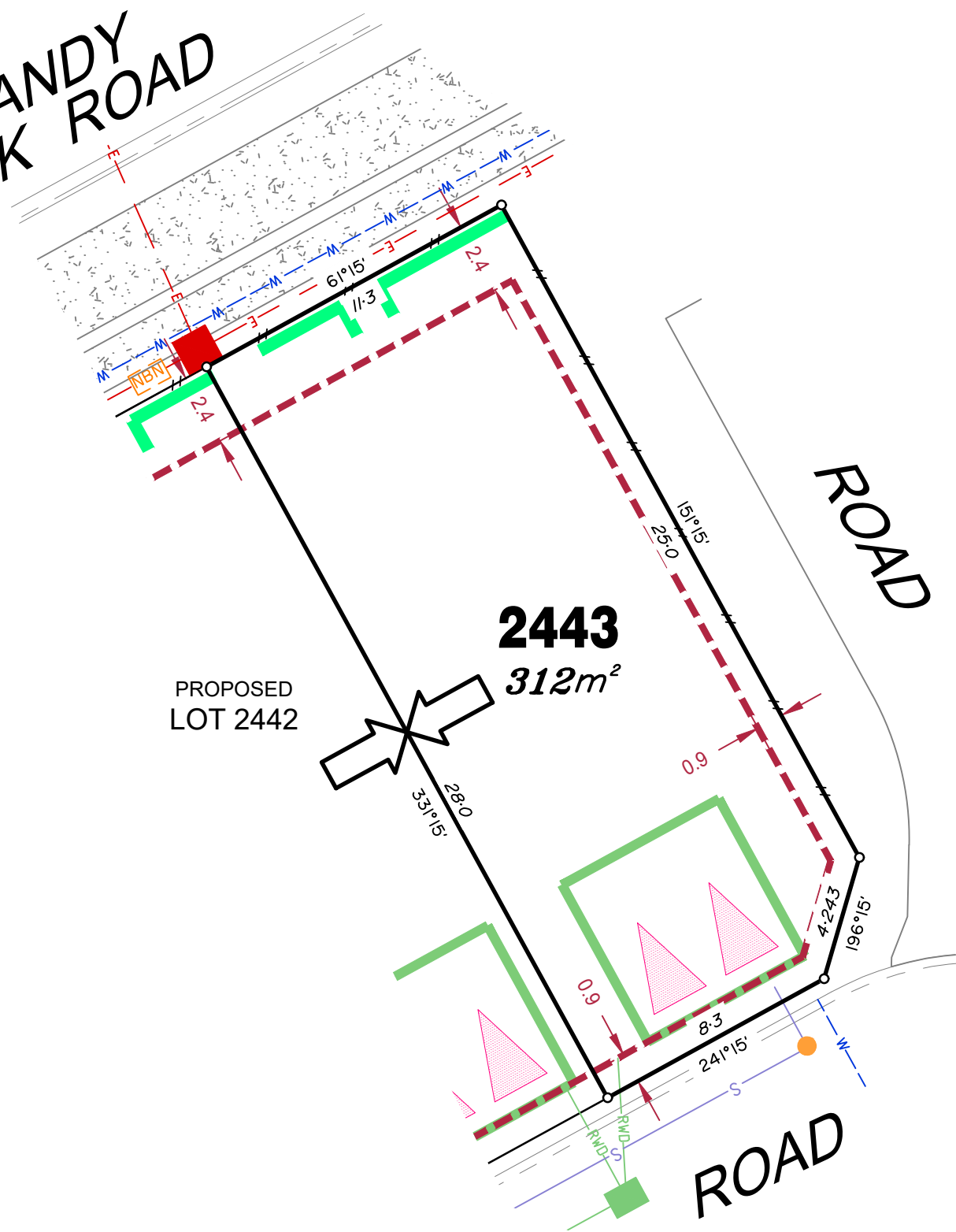

PROPOSED LOT 2442

2443
312m²

LEGEND

- Rock Retaining Wall shown as:-
- Sleeper Retaining Wall shown as:-
- Landscape Retaining Wall shown as:-
- Sewer line
- Sewer Manhole
- Roofwater Drainage line and Catch Pit
- Stormwater Drainage Line
- Stormwater Manhole
- Water Main
- Water Conduit
- Water Service Point of Entry
- Underground Electricity, Street Light, Electricity Pillar & NBN
- Developer Fencing
- Concrete Pathway
- Landscape Street Tree
- Zero Setback Building Line
- Indicative Building Envelope
- Proposed Services Easement
- Indicative Parking Access Location
- Bin Pads

ADDITIONAL NOTES:

Allotments used as Multiple Residential Allotments in accordance with the approved Plan of Development may have a reduced primary road setback to 3.0metres as noted on the Plan of Development Table.

Compaction of any fill material placed on this site shall be completed to level one inspection and testing services in accordance with AS3798-2007.

Location of sewer, roofwater, stormwater, water reticulation and electricity lines, manholes and pits are those shown on engineering design drawings, supplied by Peak Urban and may differ from the as-constructed location.

Plan of Development information Supplied by RPS Group PLC.

Copyright © Veris Australia Pty Ltd
04 April 2022.

Plot Date: 06 Apr, 2022
Computer File Ref: 30109-St5J-SP-(A).dwg

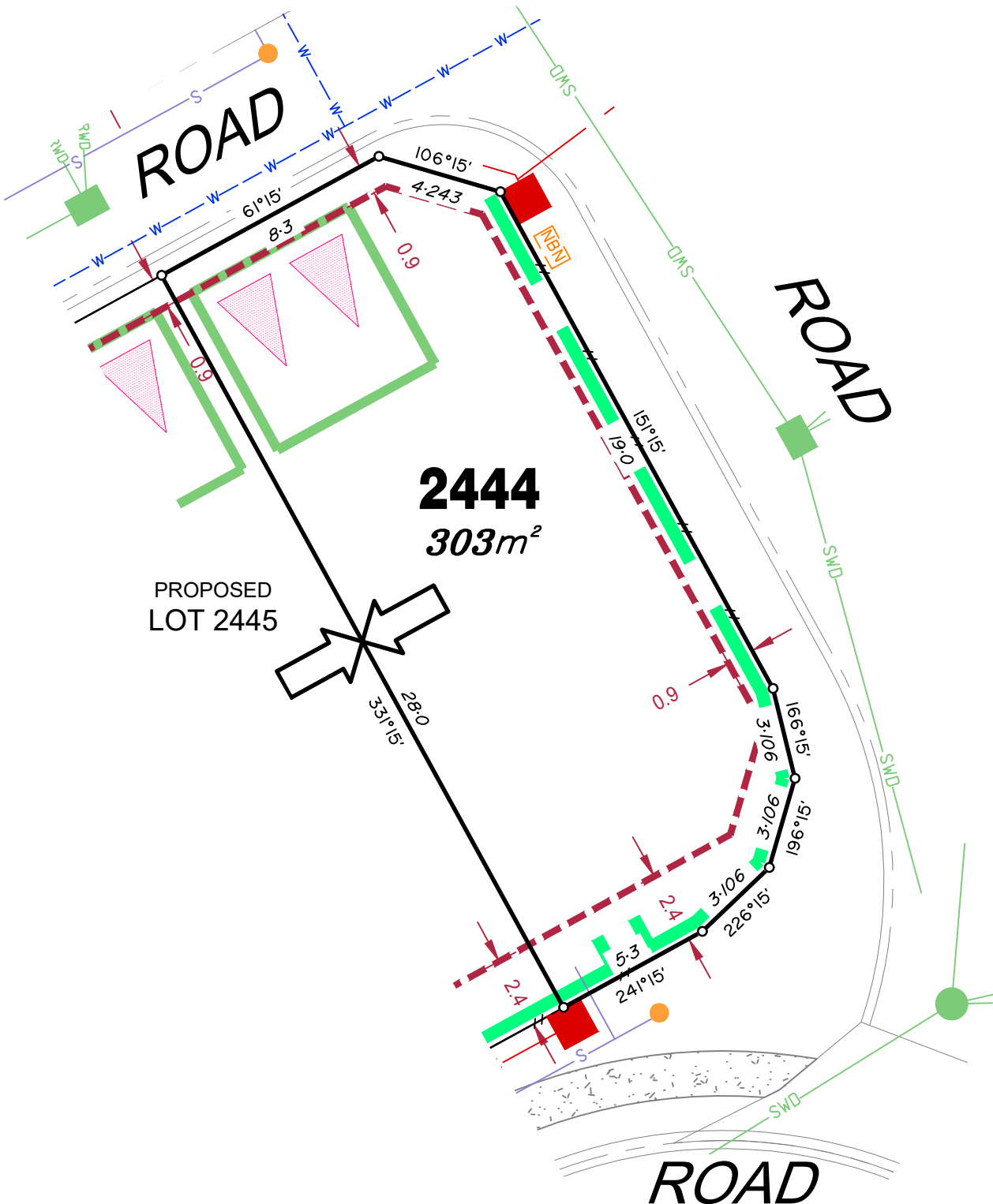

LEGEND

- Rock Retaining Wall shown as:-
- Sleeper Retaining Wall shown as:-
- Landscape Retaining Wall shown as:-
- Sewer line
- Sewer Manhole
- Roofwater Drainage line and Catch Pit
- Stormwater Drainage Line
- Stormwater Manhole
- Stormwater Pit
- Water Main
- Water Conduit
- Water Service Point of Entry
- Underground Electricity, Street Light, Electricity Pillar & NBN
- Developer Fencing
- Concrete Pathway
- Landscape Street Tree
- Zero Setback Building Line
- Indicative Building Envelope
- Proposed Services Easement
- Indicative Parking Access Location
- Bin Pads

ADDITIONAL NOTES:

Allotments used as Multiple Residential Allotments in accordance with the approved Plan of Development may have a reduced primary road setback to 3.0metres as noted on the Plan of Development Table.

Compaction of any fill material placed on this site shall be completed to level one inspection and testing services in accordance with AS3798-2007.

Location of sewer, roofwater, stormwater, water reticulation and electricity lines, manholes and pits are those shown on engineering design drawings, supplied by Peak Urban and may differ from the as-constructed location.

Plan of Development information Supplied by RPS Group PLC.

Copyright © Veris Australia Pty Ltd
04 April 2022.

Plot Date: 06 Apr, 2022
 Computer File Ref: 30109-St5J-SP-(A).dwg

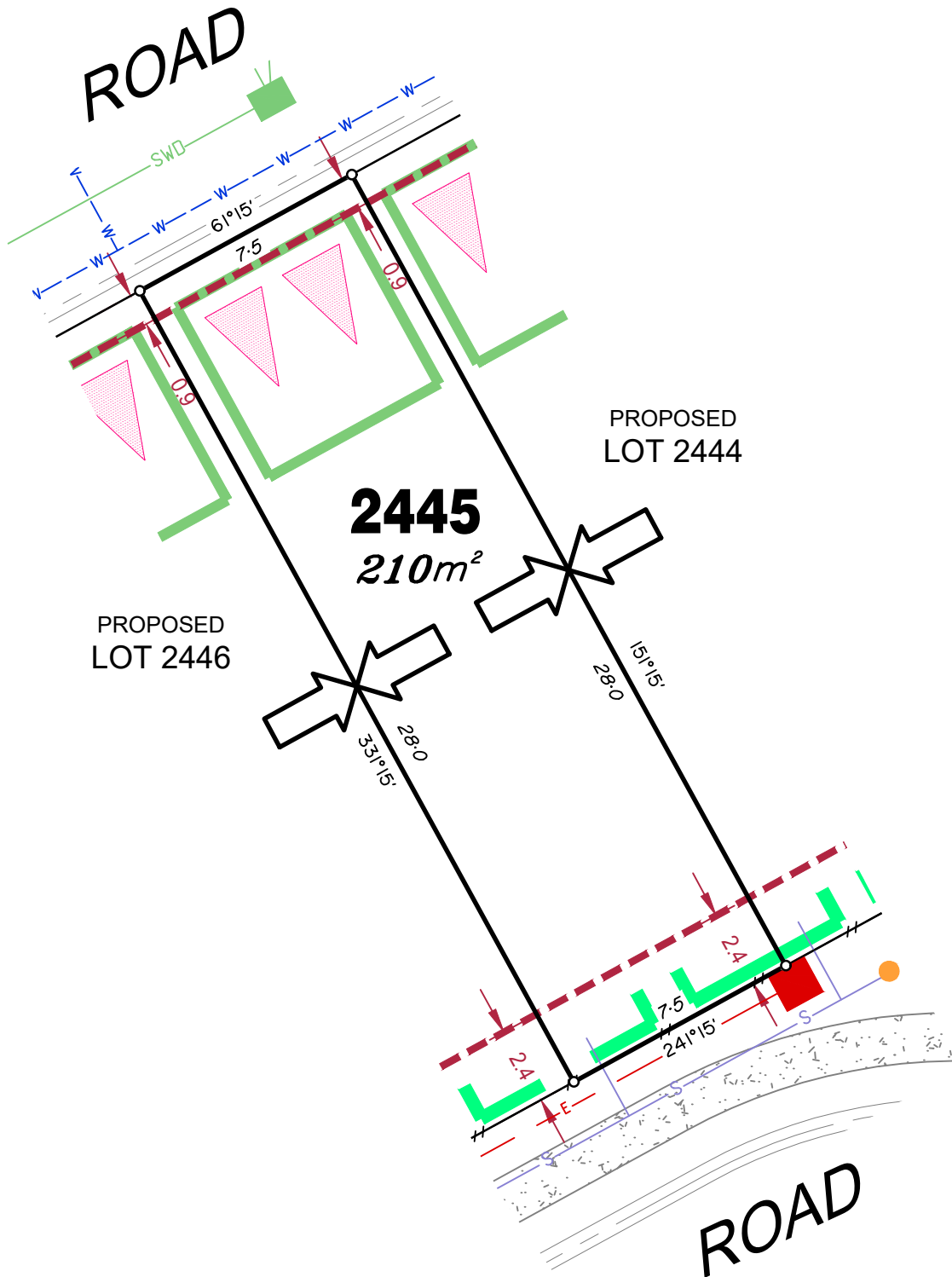

LEGEND

Rock Retaining Wall shown as:-	
Sleeper Retaining Wall shown as:-	
Landscape Retaining Wall shown as:-	
Sewer line	
Sewer Manhole	
Roofwater Drainage line and Catch Pit	
Stormwater Drainage Line	
Stormwater Manhole	
Stormwater Pit	
Water Main	
Water Conduit	
Water Service Point of Entry	
Underground Electricity, Street Light, Electricity Pillar & NBN	
Developer Fencing	
Concrete Pathway	
Landscape Street Tree	
Zero Setback Building Line	
Indicative Building Envelope	
Proposed Services Easement	
Indicative Parking Access Location	
Bin Pads	

ADDITIONAL NOTES:

Allotments used as Multiple Residential Allotments in accordance with the approved Plan of Development may have a reduced primary road setback to 3.0metres as noted on the Plan of Development Table.

Compaction of any fill material placed on this site shall be completed to level one inspection and testing services in accordance with AS3798-2007.

Location of sewer, roofwater, stormwater, water reticulation and electricity lines, manholes and pits are those shown on engineering design drawings, supplied by Peak Urban and may differ from the as-constructed location.

Plan of Development information Supplied by RPS Group PLC.

Copyright © Veris Australia Pty Ltd
04 April 2022.

Plot Date: 06 Apr, 2022
Computer File Ref: 30109-St5J-SP-(A).dwg

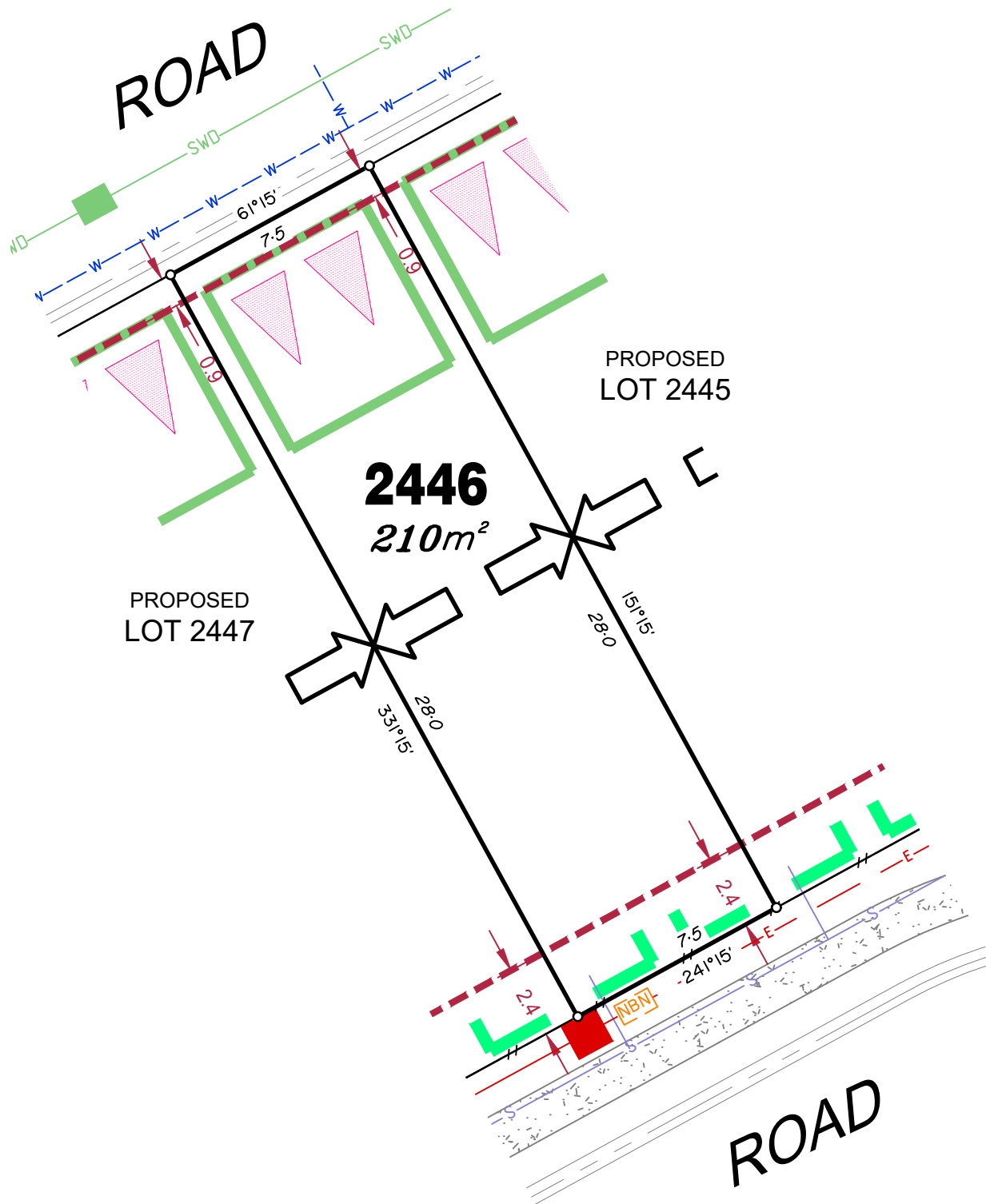

LEGEND

Rock Retaining Wall shown as:-	
Sleeper Retaining Wall shown as:-	
Landscape Retaining Wall shown as:-	
Sewer line	
Sewer Manhole	
Roofwater Drainage line and Catch Pit	
Stormwater Drainage Line	
Stormwater Manhole	
Stormwater Pit	
Water Main	
Water Conduit	
Water Service Point of Entry	
Underground Electricity, Street Light, Electricity Pillar & NBN	
Developer Fencing	
Concrete Pathway	
Landscape Street Tree	
Zero Setback Building Line	
Indicative Building Envelope	
Proposed Services Easement	
Indicative Parking Access Location	
Bin Pads	

ADDITIONAL NOTES:

Allotments used as Multiple Residential Allotments in accordance with the approved Plan of Development may have a reduced primary road setback to 3.0metres as noted on the Plan of Development Table.

Compaction of any fill material placed on this site shall be completed to level one inspection and testing services in accordance with AS3798-2007.

Location of sewer, roofwater, stormwater, water reticulation and electricity lines, manholes and pits are those shown on engineering design drawings, supplied by Peak Urban and may differ from the as-constructed location.

Plan of Development information Supplied by RPS Group PLC.

Copyright © Veris Australia Pty Ltd
04 April 2022.

Plot Date: 06 Apr, 2022
Computer File Ref: 30109-St5J-SP-(A).dwg

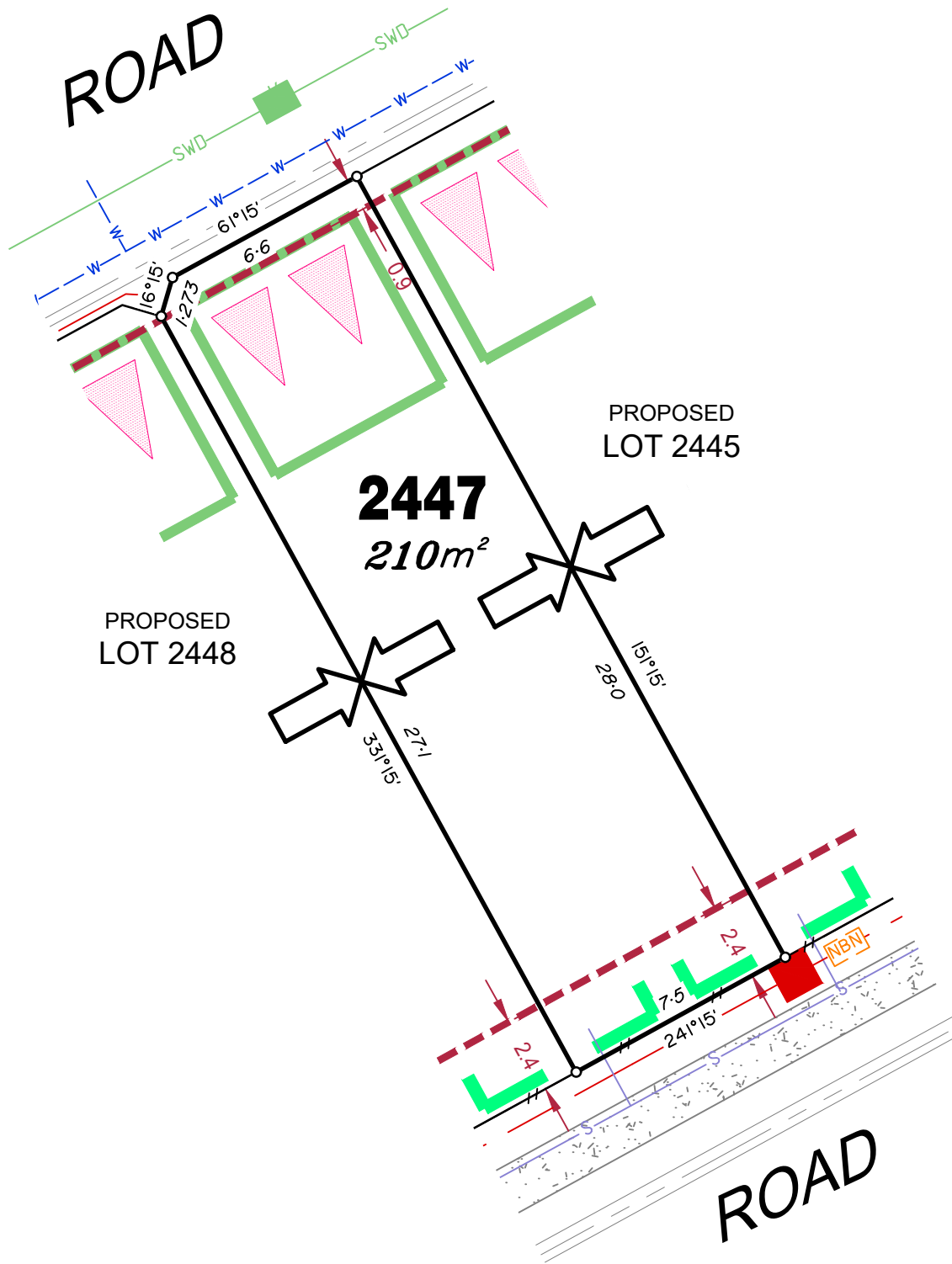

LEGEND

- Rock Retaining Wall shown as:-
- Sleeper Retaining Wall shown as:-
- Landscape Retaining Wall shown as:-
- Sewer line
- Sewer Manhole
- Roofwater Drainage line and Catch Pit
- Stormwater Drainage Line
- Stormwater Manhole
- Stormwater Pit
- Water Main
- Water Conduit
- Water Service Point of Entry
- Underground Electricity, Street Light, Electricity Pillar & NBN
- Developer Fencing
- Concrete Pathway
- Landscape Street Tree
- Zero Setback Building Line
- Indicative Building Envelope
- Proposed Services Easement
- Indicative Parking Access Location
- Bin Pads

ADDITIONAL NOTES:

Allotments used as Multiple Residential Allotments in accordance with the approved Plan of Development may have a reduced primary road setback to 3.0metres as noted on the Plan of Development Table.

Compaction of any fill material placed on this site shall be completed to level one inspection and testing services in accordance with AS3798-2007.

Location of sewer, roofwater, stormwater, water reticulation and electricity lines, manholes and pits are those shown on engineering design drawings, supplied by Peak Urban and may differ from the as-constructed location.

Plan of Development information Supplied by RPS Group PLC.

Copyright © Veris Australia Pty Ltd
04 April 2022.

Plot Date: 06 Apr, 2022
 Computer File Ref: 30109-St5J-SP-(A).dwg

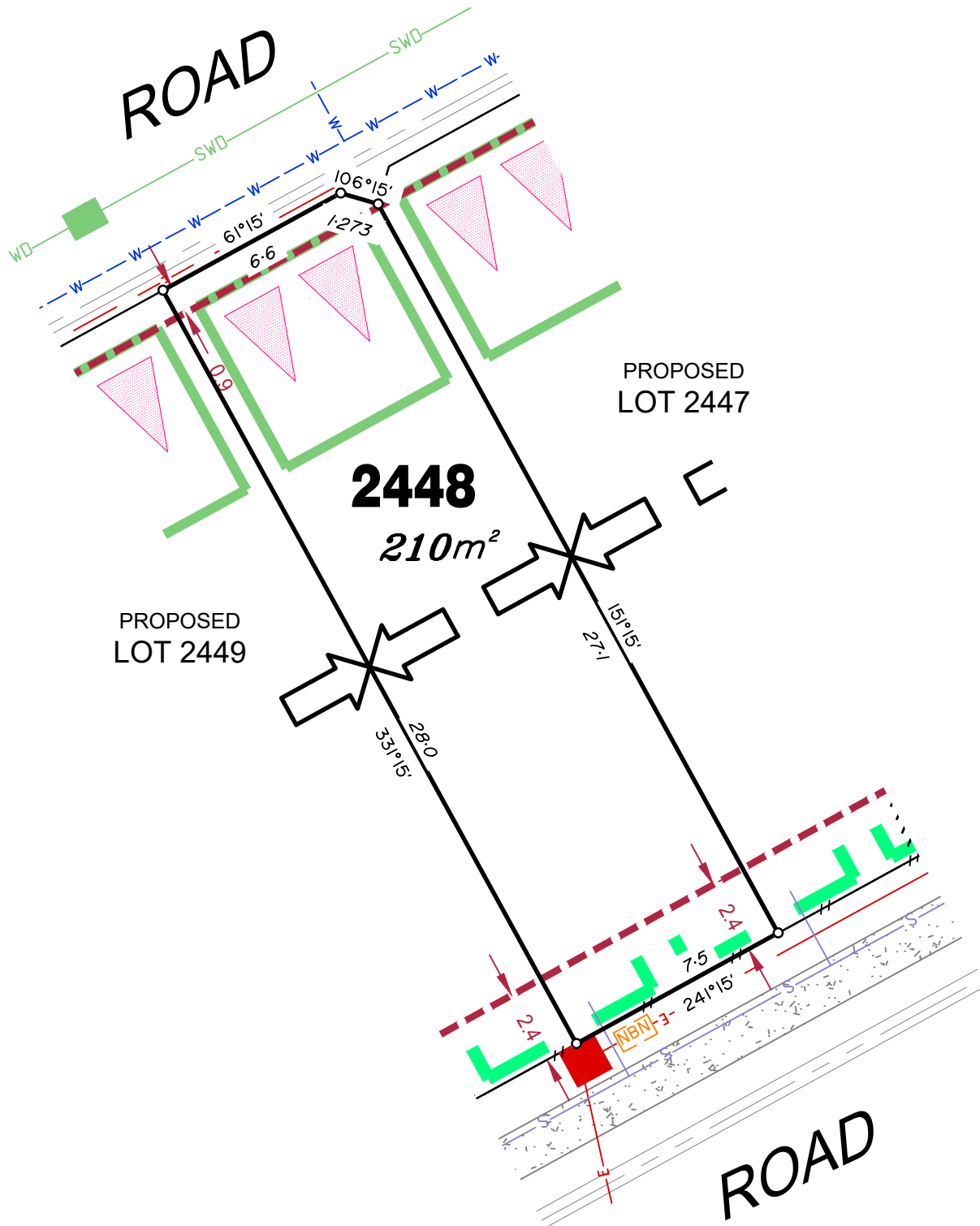

LEGEND

- Rock Retaining Wall shown as:-
- Sleeper Retaining Wall shown as:-
- Landscape Retaining Wall shown as:-
- Sewer line
- Sewer Manhole
- Roofwater Drainage line and Catch Pit
- Stormwater Drainage Line
- Stormwater Manhole
- Stormwater Pit
- Water Main
- Water Conduit
- Water Service Point of Entry
- Underground Electricity, Street Light, Electricity Pillar & NBN
- Developer Fencing
- Concrete Pathway
- Landscape Street Tree
- Zero Setback Building Line
- Indicative Building Envelope
- Proposed Services Easement
- Indicative Parking Access Location
- Bin Pads

ADDITIONAL NOTES:

Allotments used as Multiple Residential Allotments in accordance with the approved Plan of Development may have a reduced primary road setback to 3.0metres as noted on the Plan of Development Table.

Compaction of any fill material placed on this site shall be completed to level one inspection and testing services in accordance with AS3798-2007.

























Location of sewer, roofwater, stormwater, water reticulation and electricity lines, manholes and pits are those shown on engineering design drawings, supplied by Peak Urban and may differ from the as-constructed location.

Plan of Development information Supplied by RPS Group PLC.

Copyright © Veris Australia Pty Ltd
04 April 2022.

Plot Date: 06 Apr, 2022
 Computer File Ref: 30109-St5J-SP-(A).dwg

LEGEND

Rock Retaining Wall shown as:-		
Sleeper Retaining Wall shown as:-		
Landscape Retaining Wall shown as:-		
Sewer line		
Sewer Manhole		
Roofwater Drainage line and Catch Pit		
Stormwater Drainage Line		
Stormwater Manhole		
Stormwater Pit		
Water Main		
Water Conduit		
Water Service Point of Entry		
Underground Electricity, Street Light, Electricity Pillar & NBN		
Developer Fencing		
Concrete Pathway		Landscape Street Tree 
Zero Setback Building Line		Indicative Building Envelope 
Proposed Services Easement		
Indicative Parking Access Location		
Bin Pads		

ADDITIONAL NOTES:

Allotments used as Multiple Residential Allotments in accordance with the approved Plan of Development may have a reduced primary road setback to 3.0metres as noted on the Plan of Development Table.

Compaction of any fill material placed on this site shall be completed to level one inspection and testing services in accordance with AS3798-2007.

Location of sewer, roofwater, stormwater, water reticulation and electricity lines, manholes and pits are those shown on engineering design drawings, supplied by Peak Urban and may differ from the as-constructed location.

Plan of Development information Supplied by RPS Group PLC.





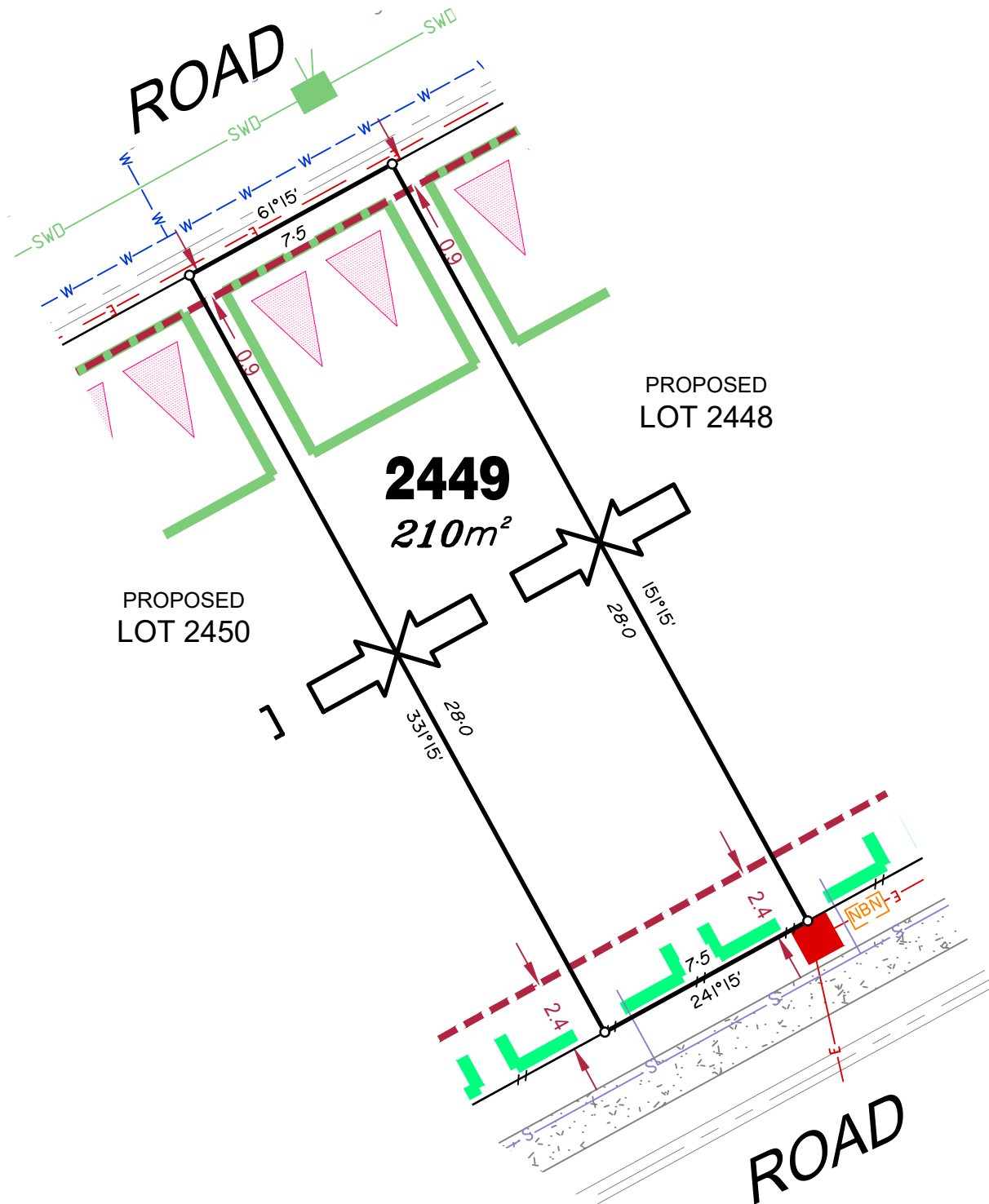

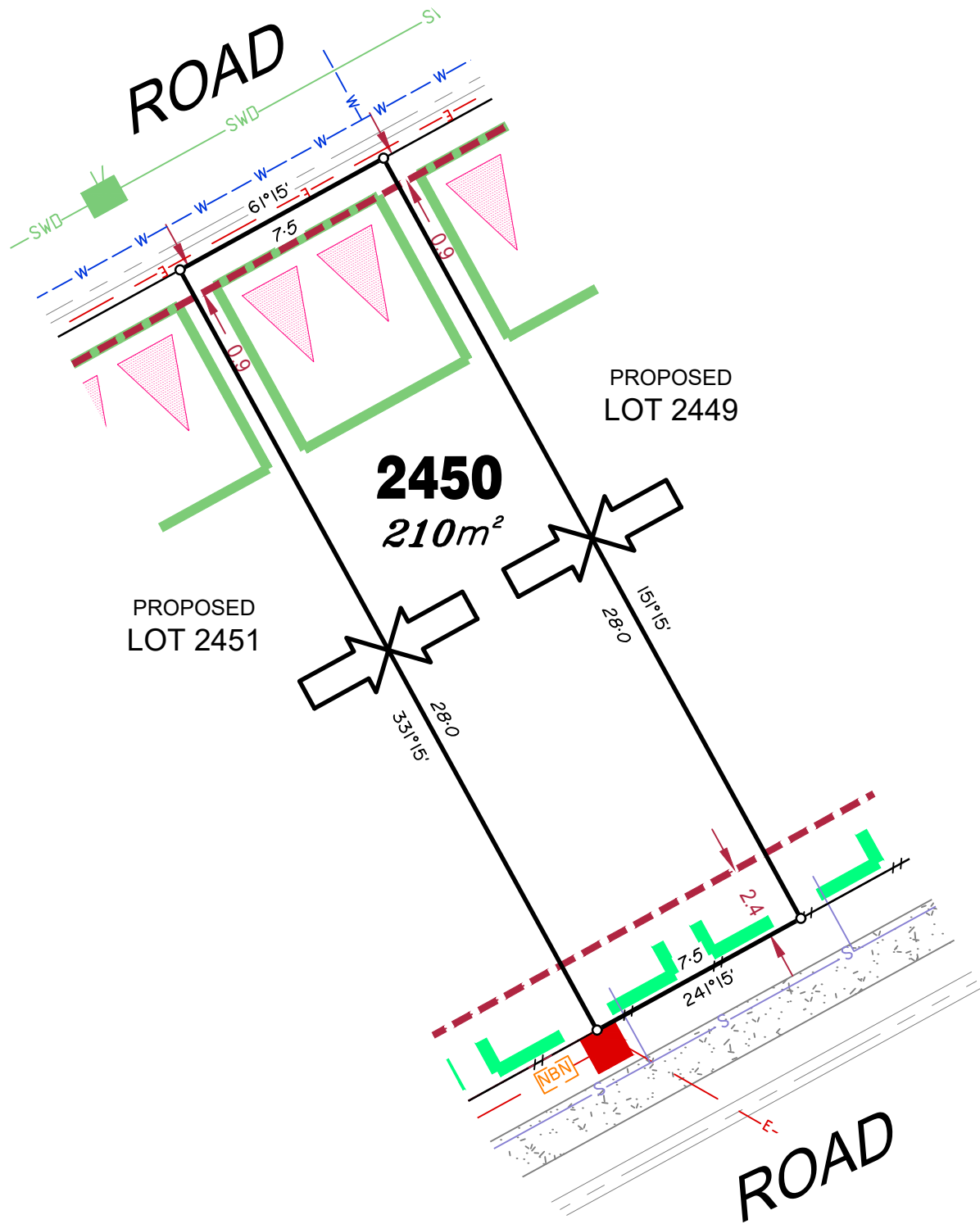













Copyright © Veris Australia Pty Ltd
04 April 2022.

Plot Date: 06 Apr, 2022
Computer File Ref: 30109-St5J-SP-(A).dwg





LEGEND

- Rock Retaining Wall shown as:- 
- Sleeper Retaining Wall shown as:- 
- Landscape Retaining Wall shown as:- 
- Sewer line 
- Sewer Manhole 
- Roofwater Drainage line and Catch Pit 
- Stormwater Drainage Line 
- Stormwater Manhole 
- Stormwater Pit 
- Water Main 
- Water Conduit 
- Water Service Point of Entry 
- Underground Electricity, Street Light, Electricity Pillar & NBN 
- Developer Fencing 
- Concrete Pathway 
- Landscape Street Tree 
- Zero Setback Building Line 
- Indicative Building Envelope 
- Proposed Services Easement 
- Indicative Parking Access Location 
- Bin Pads 

ADDITIONAL NOTES:

Allotments used as Multiple Residential Allotments in accordance with the approved Plan of Development may have a reduced primary road setback to 3.0metres as noted on the Plan of Development Table.

Compaction of any fill material placed on this site shall be completed to level one inspection and testing services in accordance with AS3798-2007.

Location of sewer, roofwater, stormwater, water reticulation and electricity lines, manholes and pits are those shown on engineering design drawings, supplied by Peak Urban and may differ from the as-constructed location.

Plan of Development information Supplied by RPS Group PLC.

Copyright © Veris Australia Pty Ltd
04 April 2022.

Plot Date: 06 Apr, 2022
Computer File Ref: 30109-St5J-SP-(A).dwg

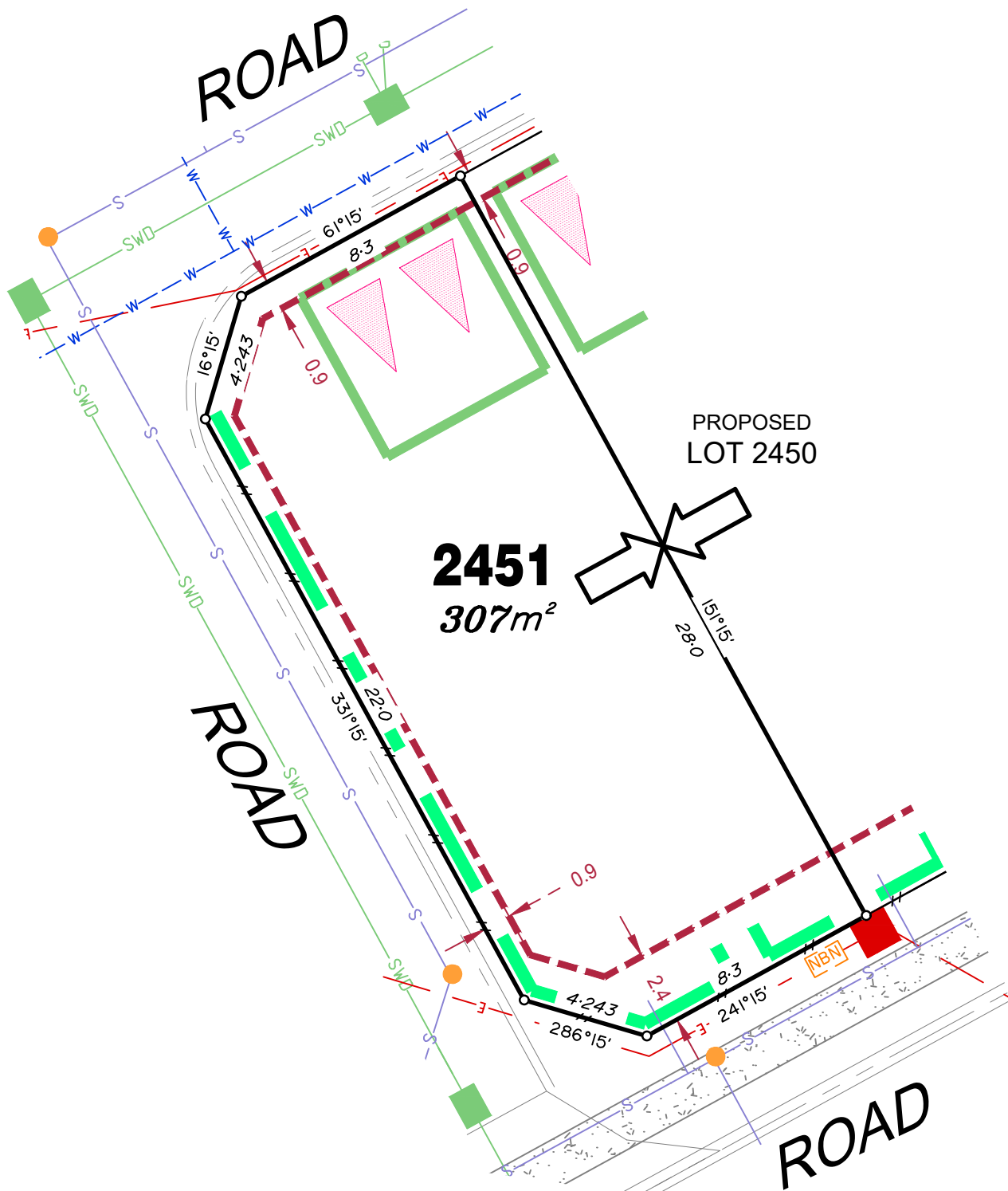

LEGEND

- Rock Retaining Wall shown as:-
- Sleeper Retaining Wall shown as:-
- Landscape Retaining Wall shown as:-
- Sewer line
- Sewer Manhole
- Roofwater Drainage line and Catch Pit
- Stormwater Drainage Line
- Stormwater Manhole
- Water Main
- Water Conduit
- Water Service Point of Entry
- Underground Electricity, Street Light, Electricity Pillar & NBN
- Developer Fencing
- Concrete Pathway
- Landscape Street Tree
- Zero Setback Building Line
- Indicative Building Envelope
- Proposed Services Easement
- Indicative Parking Access Location
- Bin Pads

ADDITIONAL NOTES:

Allotments used as Multiple Residential Allotments in accordance with the approved Plan of Development may have a reduced primary road setback to 3.0metres as noted on the Plan of Development Table.

Compaction of any fill material placed on this site shall be completed to level one inspection and testing services in accordance with AS3798-2007.

Location of sewer, roofwater, stormwater, water reticulation and electricity lines, manholes and pits are those shown on engineering design drawings, supplied by Peak Urban and may differ from the as-constructed location.

Plan of Development information Supplied by RPS Group PLC.

Copyright © Veris Australia Pty Ltd
04 April 2022.

Plot Date: 06 Apr, 2022
Computer File Ref: 30109-St5J-SP-(A).dwg

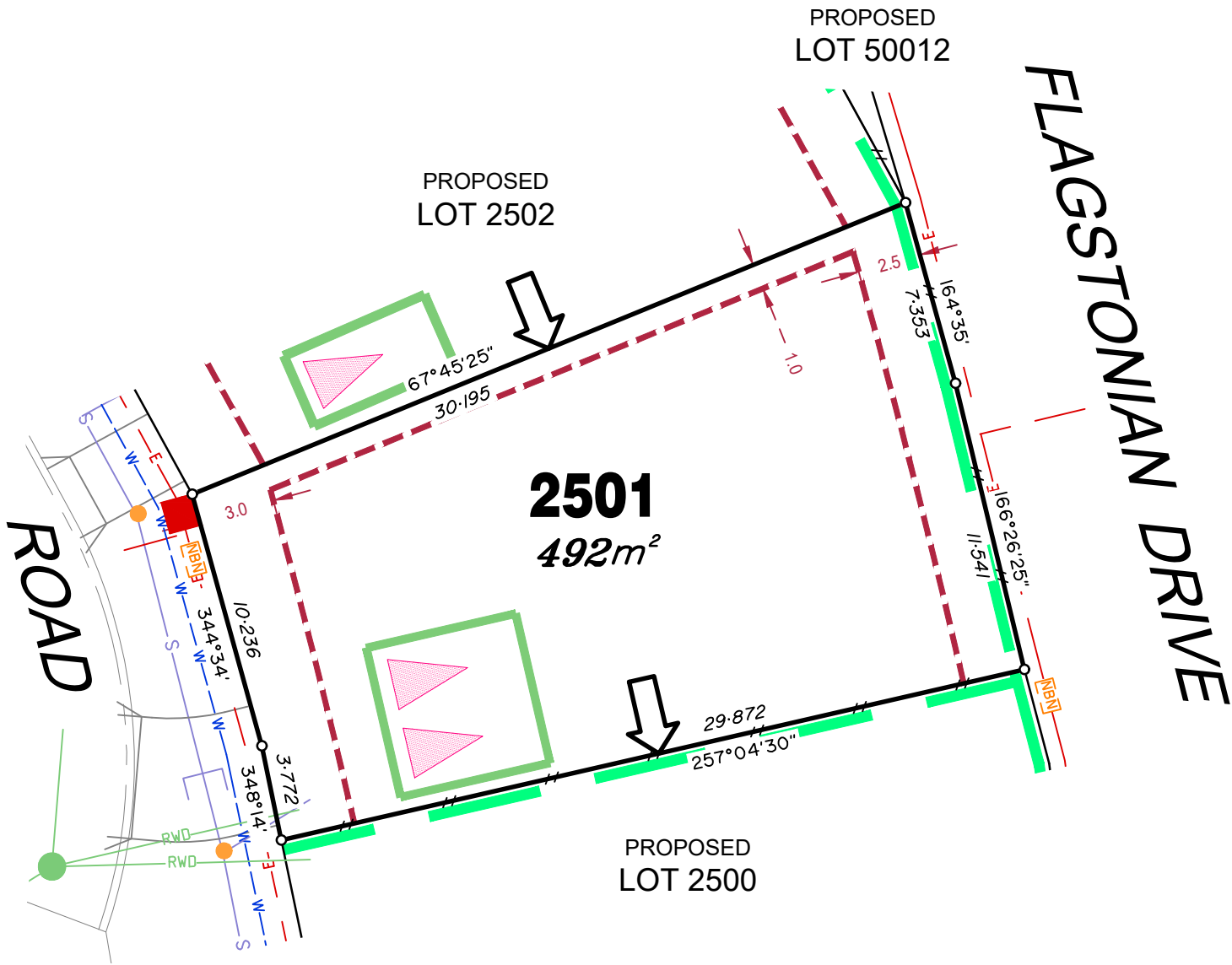

LEGEND

Rock Retaining Wall shown as:-	
Sleeper Retaining Wall shown as:-	
Landscape Retaining Wall shown as:-	
Sewer line	
Sewer Manhole	
Roofwater Drainage line and Catch Pit	
Stormwater Drainage Line	
Stormwater Manhole	
Stormwater Pit	
Water Main	
Water Conduit	
Water Service Point of Entry	
Underground Electricity, Street Light, Electricity Pillar & NBN	
Developer Fencing	
Concrete Pathway	
Landscape Street Tree	
Zero Setback Building Line	
Indicative Building Envelope	
Proposed Services Easement	
Indicative Parking Access Location	
Bin Pads	

ADDITIONAL NOTES:

Allotments used as Multiple Residential Allotments in accordance with the approved Plan of Development may have a reduced primary road setback to 3.0metres as noted on the Plan of Development Table.

Compaction of any fill material placed on this site shall be completed to level one inspection and testing services in accordance with AS3798-2007.

Location of sewer, roofwater, stormwater, water reticulation and electricity lines, manholes and pits are those shown on engineering design drawings, supplied by Peak Urban and may differ from the as-constructed location.

Plan of Development information Supplied by RPS Group PLC.

Copyright © Veris Australia Pty Ltd
04 April 2022.

Plot Date: 06 Apr, 2022
Computer File Ref: 30109-St5J-SP-(A).dwg

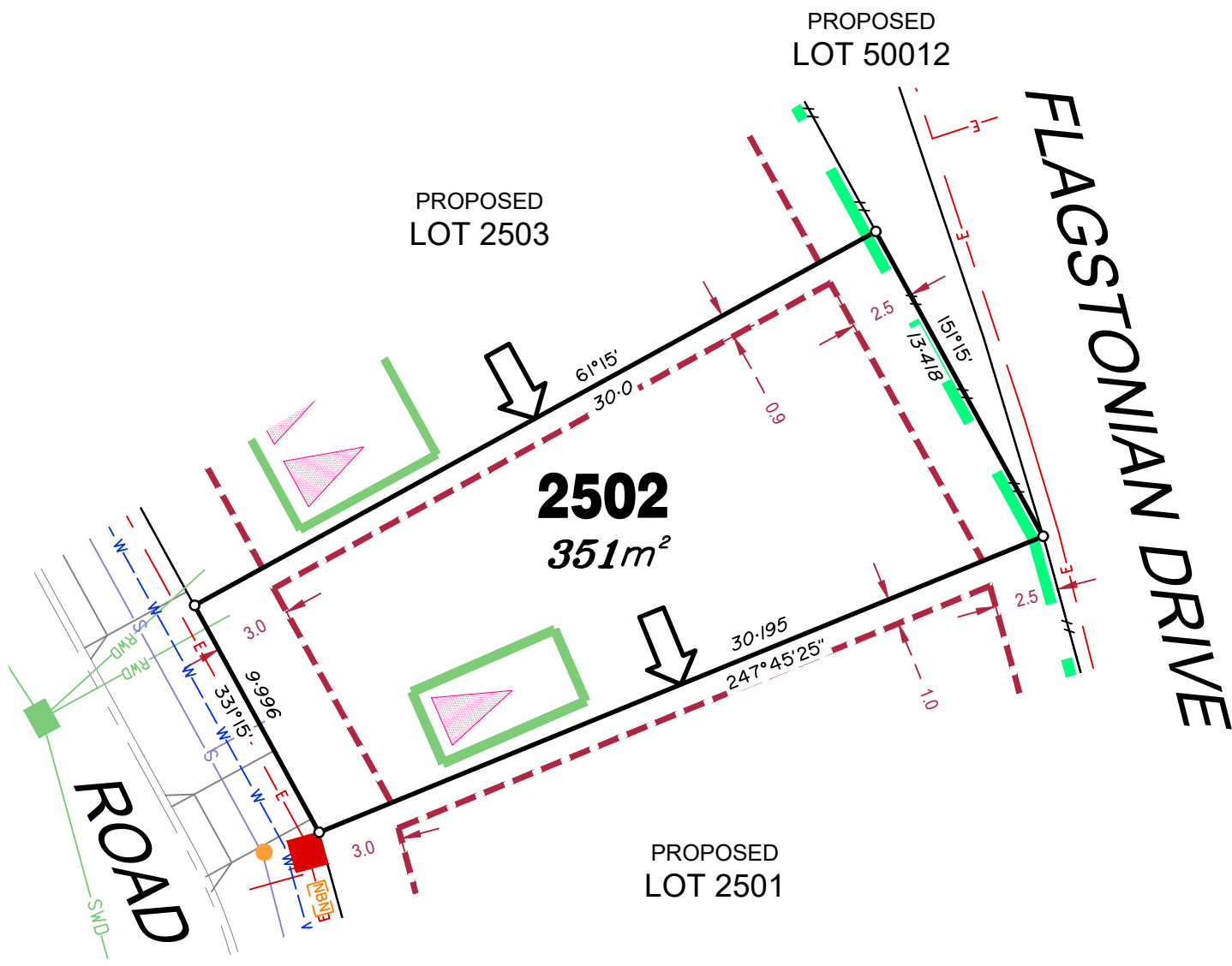

LEGEND

- Rock Retaining Wall shown as:-
- Sleeper Retaining Wall shown as:-
- Landscape Retaining Wall shown as:-
- Sewer line
- Sewer Manhole
- Roofwater Drainage line and Catch Pit
- Stormwater Drainage Line
- Stormwater Manhole
- Stormwater Pit
- Water Main
- Water Conduit
- Water Service Point of Entry
- Underground Electricity, Street Light, Electricity Pillar & NBN
- Developer Fencing
- Concrete Pathway
- Landscape Street Tree
- Zero Setback Building Line
- Indicative Building Envelope
- Proposed Services Easement
- Indicative Parking Access Location
- Bin Pads

ADDITIONAL NOTES:

Allotments used as Multiple Residential Allotments in accordance with the approved Plan of Development may have a reduced primary road setback to 3.0metres as noted on the Plan of Development Table.

Compaction of any fill material placed on this site shall be completed to level one inspection and testing services in accordance with AS3798-2007.

Location of sewer, roofwater, stormwater, water reticulation and electricity lines, manholes and pits are those shown on engineering design drawings, supplied by Peak Urban and may differ from the as-constructed location.

Plan of Development information Supplied by RPS Group PLC.

Copyright © Veris Australia Pty Ltd
04 April 2022.

Plot Date: 06 Apr, 2022
 Computer File Ref: 30109-St5J-SP-(A).dwg

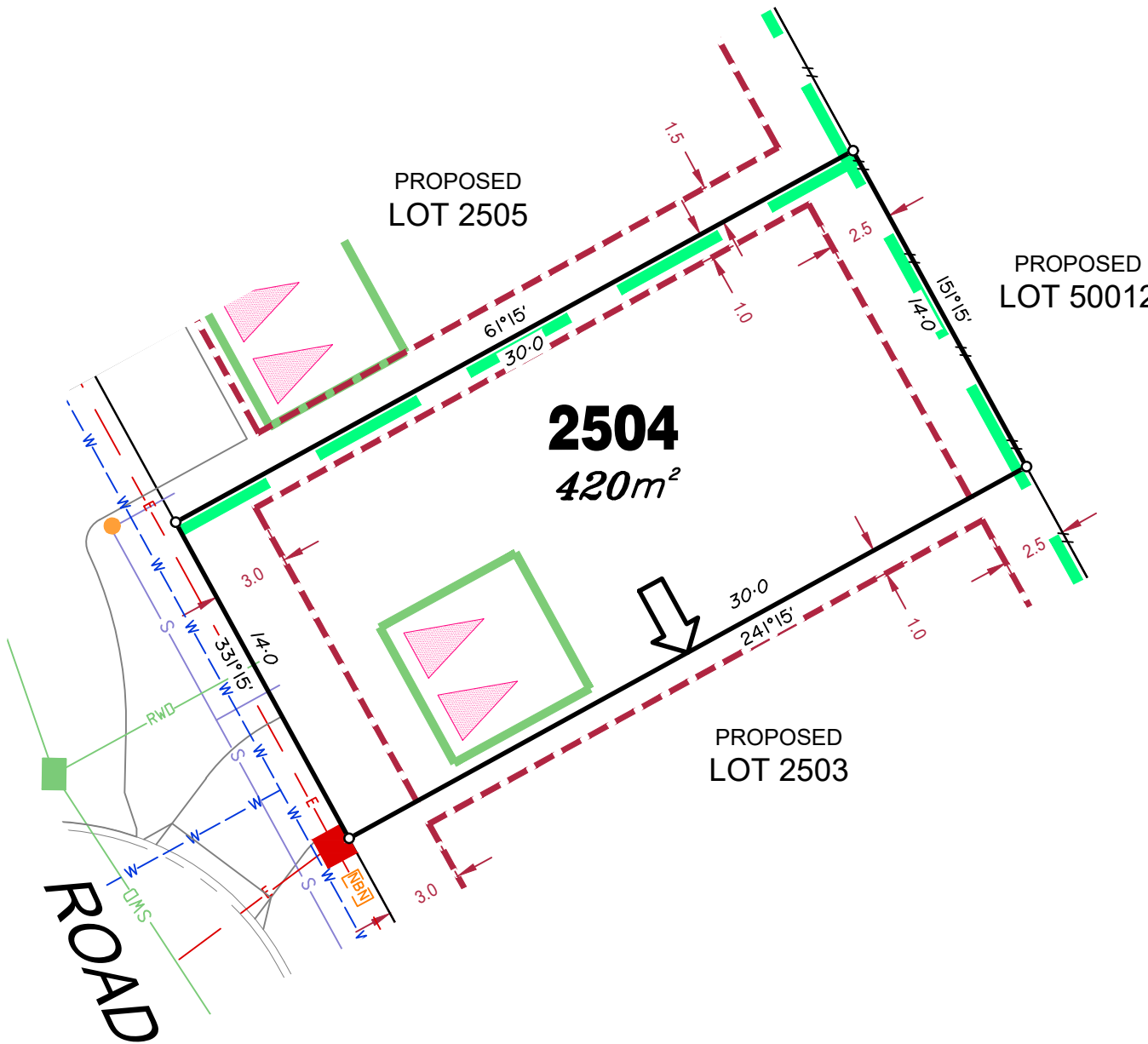

LEGEND

Rock Retaining Wall shown as:-	
Sleeper Retaining Wall shown as:-	
Landscape Retaining Wall shown as:-	
Sewer line	
Sewer Manhole	
Roofwater Drainage line and Catch Pit	
Stormwater Drainage Line	
Stormwater Manhole	
Stormwater Pit	
Water Main	
Water Conduit	
Water Service Point of Entry	
Underground Electricity, Street Light, Electricity Pillar & NBN	
Developer Fencing	
Concrete Pathway	
Landscape Street Tree	
Zero Setback Building Line	
Indicative Building Envelope	
Proposed Services Easement	
Indicative Parking Access Location	
Bin Pads	

ADDITIONAL NOTES:

Allotments used as Multiple Residential Allotments in accordance with the approved Plan of Development may have a reduced primary road setback to 3.0metres as noted on the Plan of Development Table.

Compaction of any fill material placed on this site shall be completed to level one inspection and testing services in accordance with AS3798-2007.

Location of sewer, roofwater, stormwater, water reticulation and electricity lines, manholes and pits are those shown on engineering design drawings, supplied by Peak Urban and may differ from the as-constructed location.

Plan of Development information Supplied by RPS Group PLC.

Copyright © Veris Australia Pty Ltd
04 April 2022.

Plot Date: 06 Apr, 2022
 Computer File Ref: 30109-St5J-SP-(A).dwg

